



## Cubicle Size & Layout Guide

Cubicle Sizes | Wheelchair Access Cubicles | Doc M Packs | Vanity Units | Wall Panels

[www.washroomcubicles.co.uk](http://www.washroomcubicles.co.uk)

# Cubicle Size & Layout Guide

Perfect for new build and refurbishment projects, this toolkit is designed to help you:

- Understand the various types of cubicle
- Specify toilet cubicle configurations and quantities
- Work towards Building Regs (Part M) compliance
- Save time when compiling CAD drawings

And don't forget, the team at Cubicle Centre are always on hand to assist you from the start of your project through to completion.

## Contents

Page 3	Download CAD Files
Page 4	Toilet Cubicle Sizes
Page 5	Toilet Cubicle Sizes Explained
Page 6	Wheelchair Accessible Cubicles
Page 7	Approved Document M
Page 8	Toilet Cubicles by Age and Height
Page 9	Vanity Units
Page 10	Wall Panels
Page 11	Locker Layouts and Sizes
Page 12	Changing Room Sizes
Page 13	Accessible Changing Room Sizes
Page 14	Shower Area Sizes
Page 17	Sector Washroom Guides



# Download CAD Files

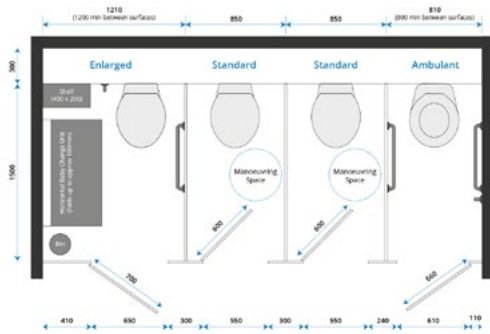

## Standard Toilet Cubicles

Cubicle sizes including Standard, Enlarged and Ambulant

[Download CAD Block](#)

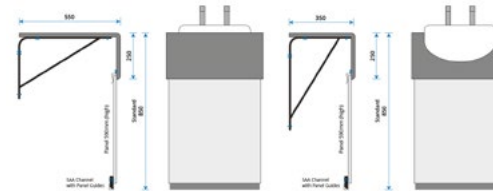

## Vanity Units

Heights and widths for vanity units including inset and semi-recessed

[Download CAD Block](#)

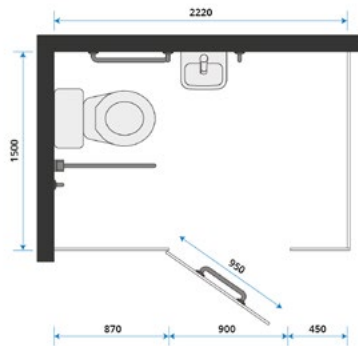

## Wheelchair Accessible Cubicles

The measurements and requirements for Wheelchair Accessible cubicles

[Download CAD Block](#)

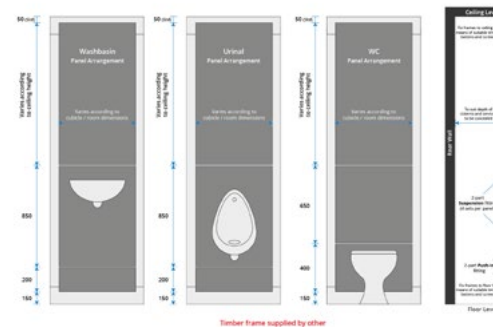

## Wall Panels

Wall panel configurations for basins, urinals and toilet pans

[Download CAD Block](#)

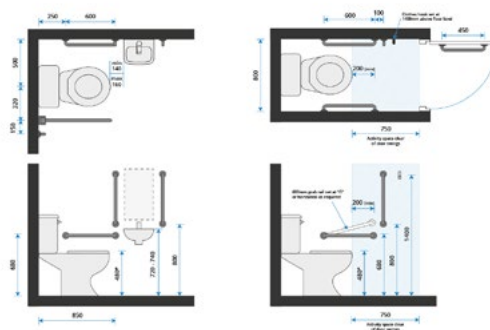

## Approved Document M

Measurements and positions for grab rails

[Download CAD Block](#)



## BIM Components

A full library of BIM components are available to download as Revit files

[View BIM Components](#)

# Toilet Cubicle Sizes

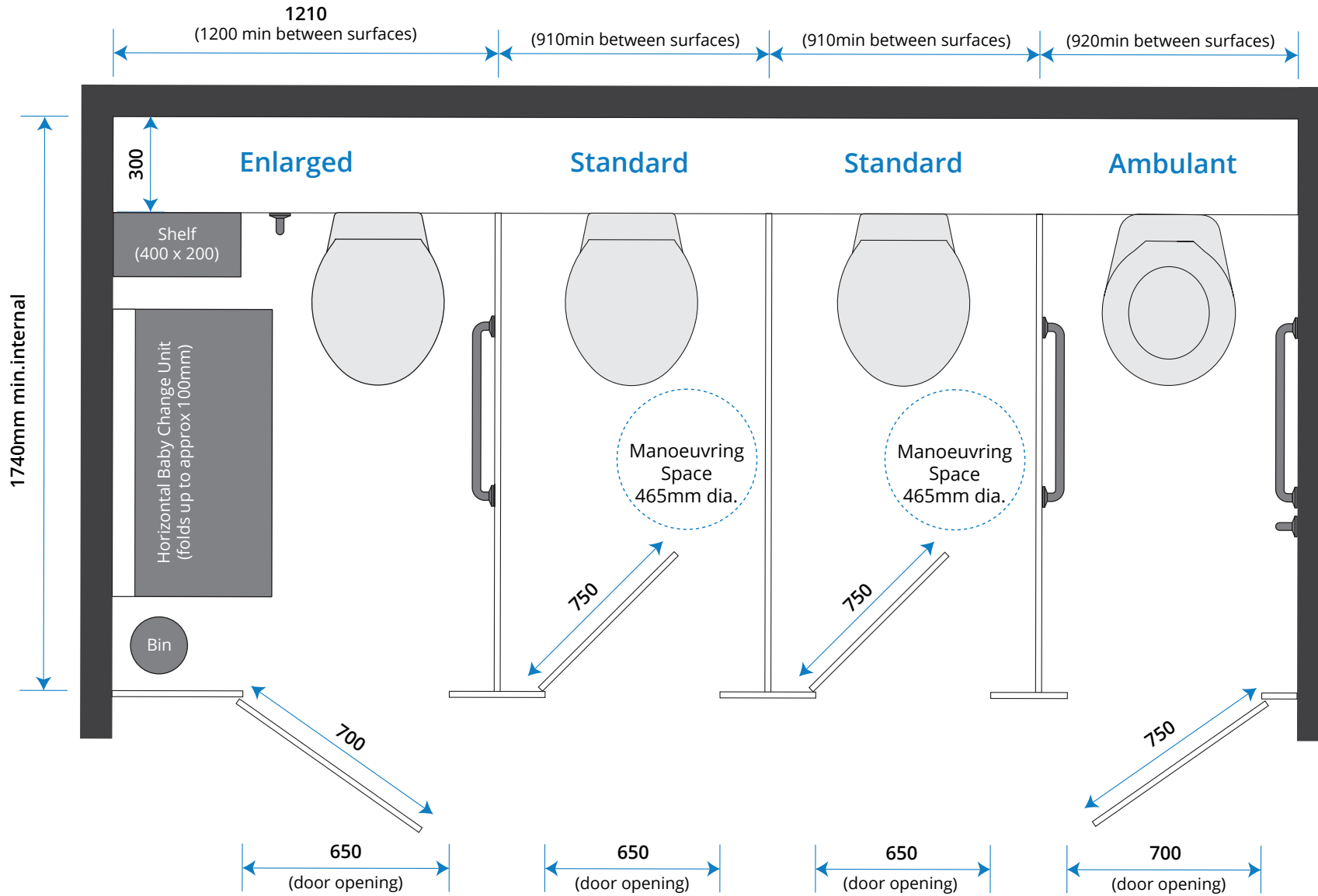

[View Cubicle Ranges](#)

---

# Toilet Cubicle Sizes Explained

---



## Enlarged WC Cubicles:

Where there are 4 or more cubicles in a washroom, one of these must be an enlarged cubicle.

Enlarged cubicles must be a minimum width of 1200mm and include an outward opening door.

A horizontal and vertical grab rail set is required around the WC.

## Standard Toilet Cubicles:

All standard cubicles must now have a minimum of 465mm diameter manoeuvring space within the cubicle.

Indicator-bolts must be capable of being operated with a closed fist (single action) - and doors must allow for emergency access should the user collapse and become trapped in the cubicle.

## Ambulant Disabled Cubicles:

Every same-sex washroom must have at least one wc cubicle that is suitable for the ambulant disabled.

If there is only one cubicle in the washroom this must be suitable for an ambulant disabled person.

The ambulant disabled cubicle must include an outward opening door.

# Wheelchair Accessible Cubicles

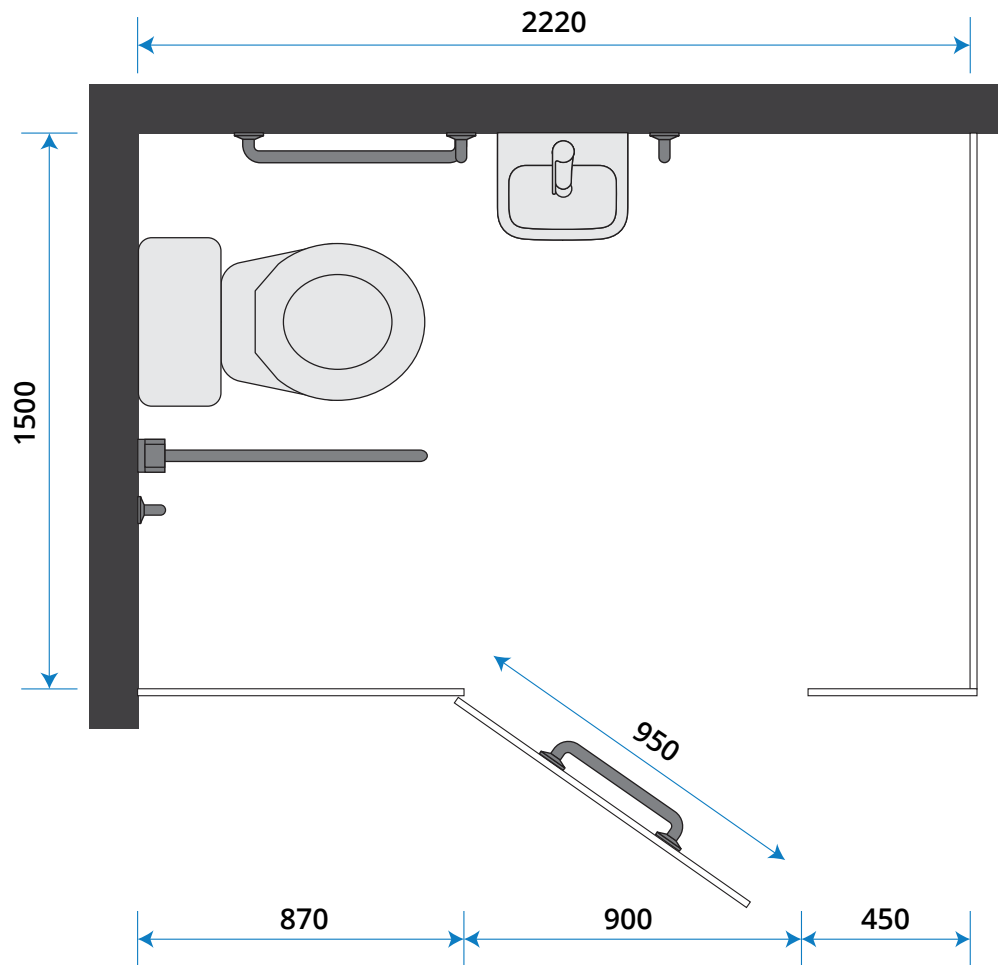

## Wheelchair Accessible Cubicles:

The wheelchair accessible layout has been modified to accommodate an overall toilet cubicle length of 2220mm (previously 2000mm).

The door opening needs to be 900mm with a 950mm (wide) outward opening door.

[Download the CAD File](#)

[View Cubicle Ranges](#)





# Toilet Cubicles by Age and Height

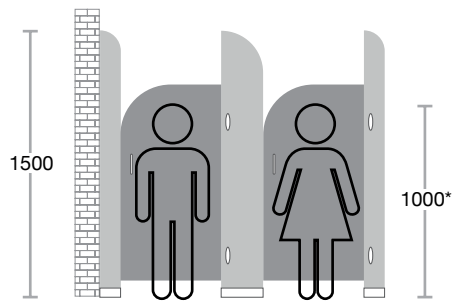

**Sydney®**  
Pre-School Toilet Cubicles

For ages 3 - 7

Ideal cubicle system for:

- Foundation Stage
- Infant Schools
- Nurseries
- Daycare Centres
- Pre-schools

[View More Info](#)



**Brecon®**  
Junior School Toilet Cubicles

For ages 7 - 13

Ideal cubicle system for:

- Junior Schools
- Primary Schools
- Middle Schools

[View More Info](#)

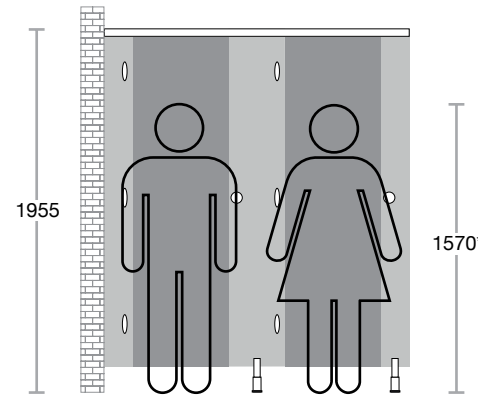

**Cairngorm®**  
Anti-Vandal Cubicles

For ages 9+

Ideal cubicle system for:

- High / Secondary Schools
- Universities
- Shower Cubicles
- Changing Rooms
- Staff Washrooms

[View More Info](#)

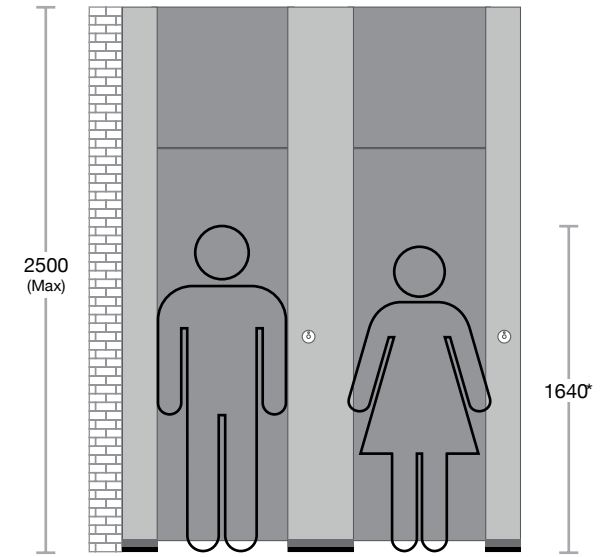

**Privacy™**  
Full Height Toilet Cubicles

For ages 13+

Ideal cubicle system for:

- High / Secondary Schools
- Universities
- Staff Washrooms
- Where privacy is important

[View More Info](#)

\* Average height of age range according to the RCPCH



# Vanity Units Sizes

## Inset Vanity Unit

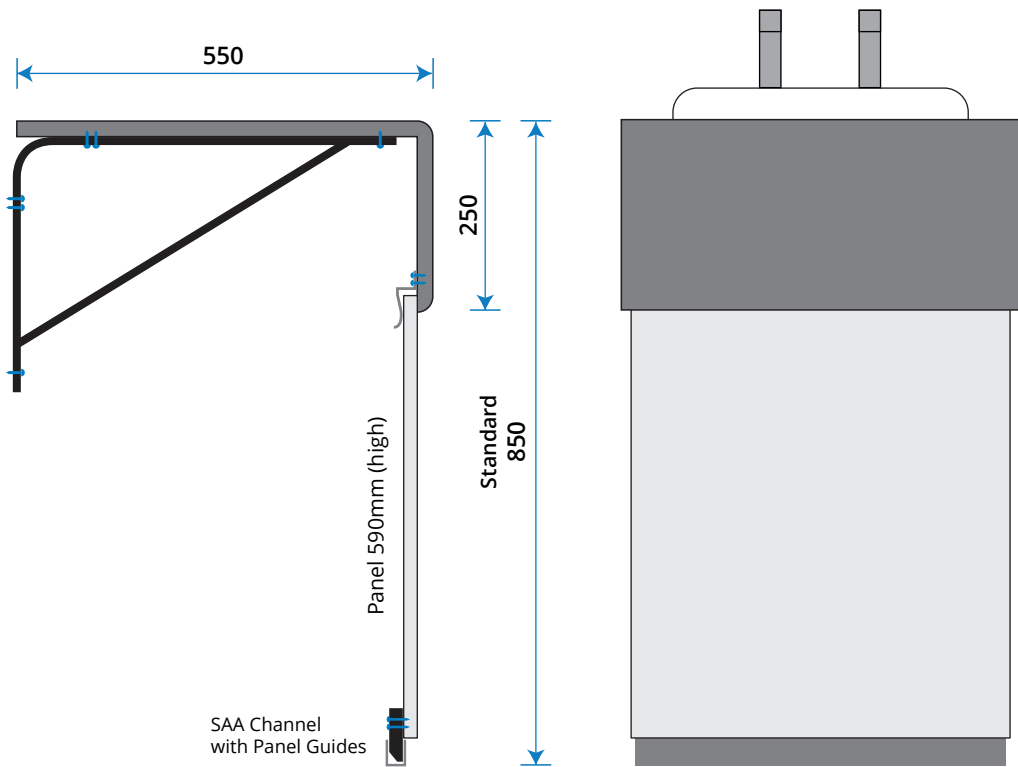

[Download the CAD File](#)

## Semi-Recessed Vanity Unit

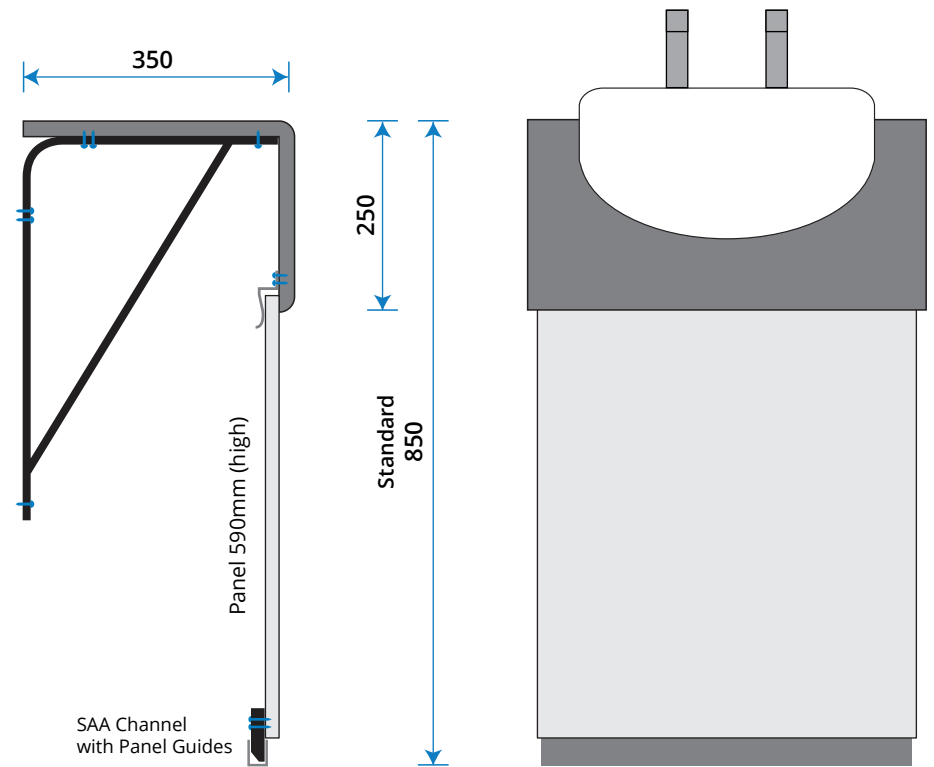

[View Vanity Details](#)

# Wall Panels Sizes

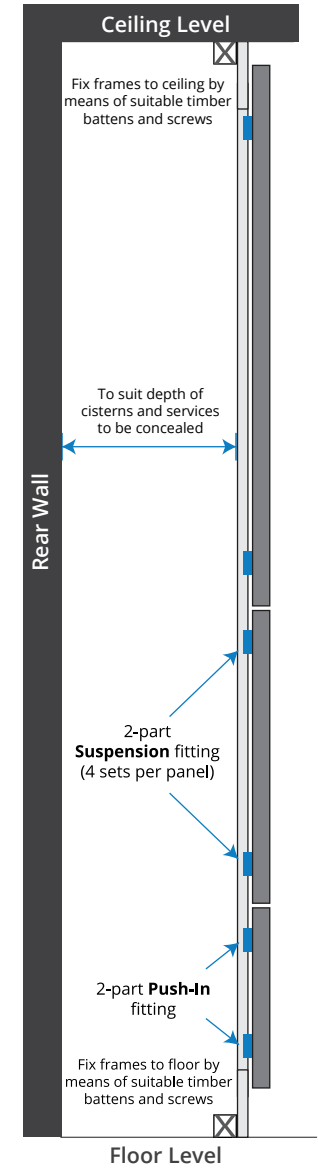
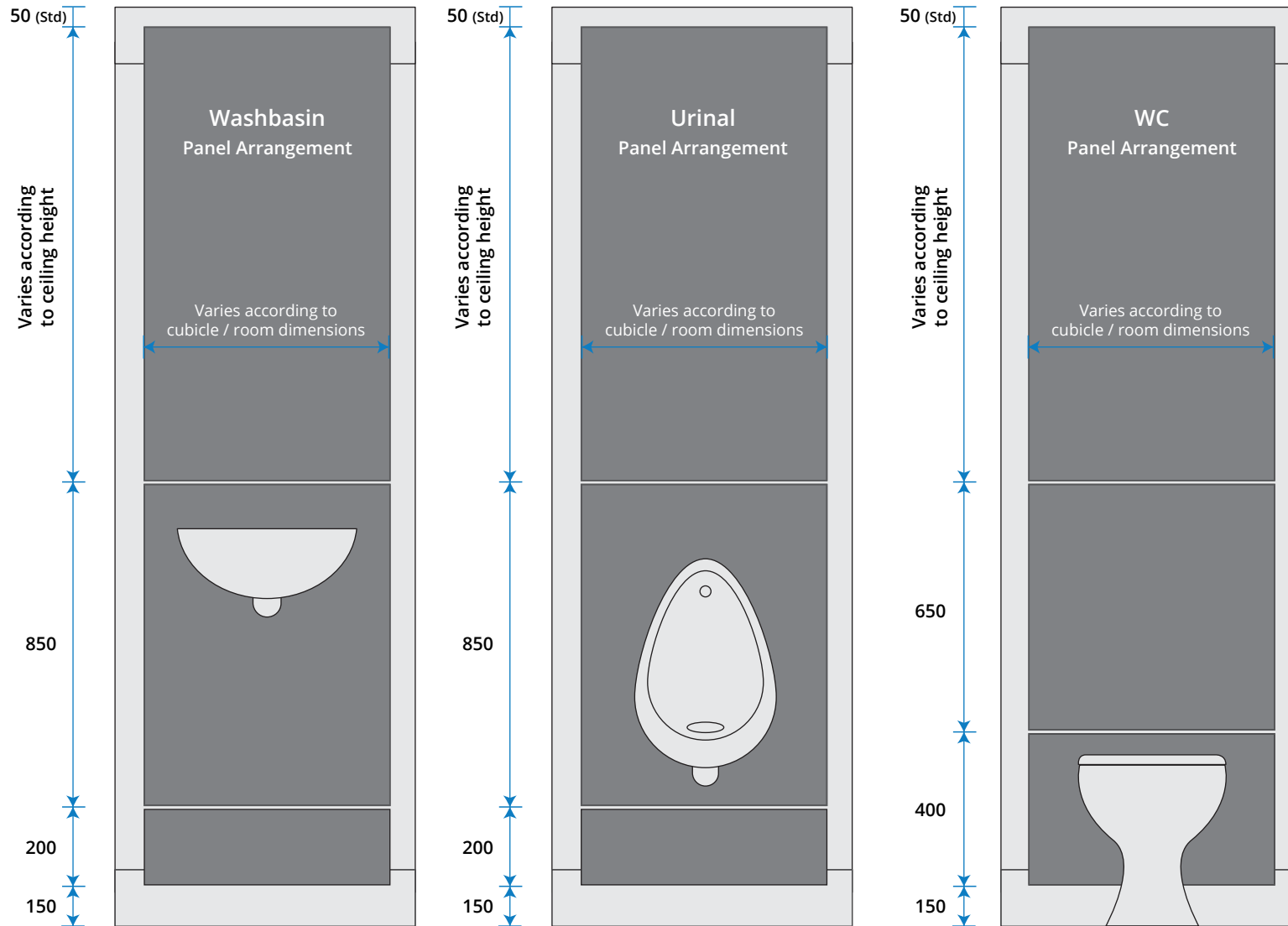

Timber frame supplied by other

[Download the CAD File](#)

[View Wall Panels Details](#)

# Locker Layouts and Sizes

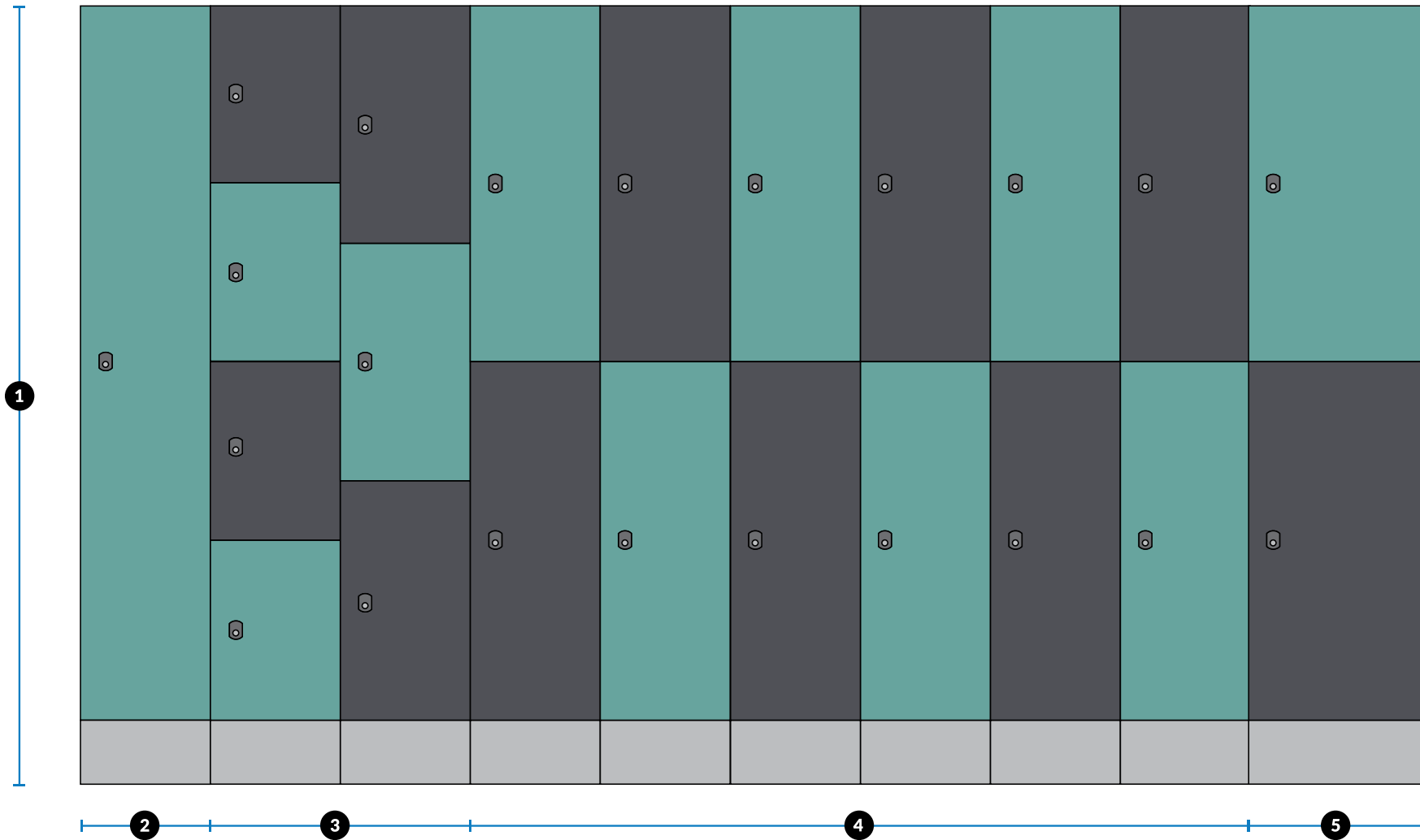

**1** Lockers are generally 1800mm high x 300mm wide and 450-600mm deep.

**2** 10% of lockers should be 'full-height' to accommodate mobility aids

**3** Quarter-height and third-height are an option if required

**4** 50-70% of the total locker provision should be half-height

**5** A proportion of lockers should be 400mm wide for sports bags.

# Changing Room Sizes

Two person changing cubicles

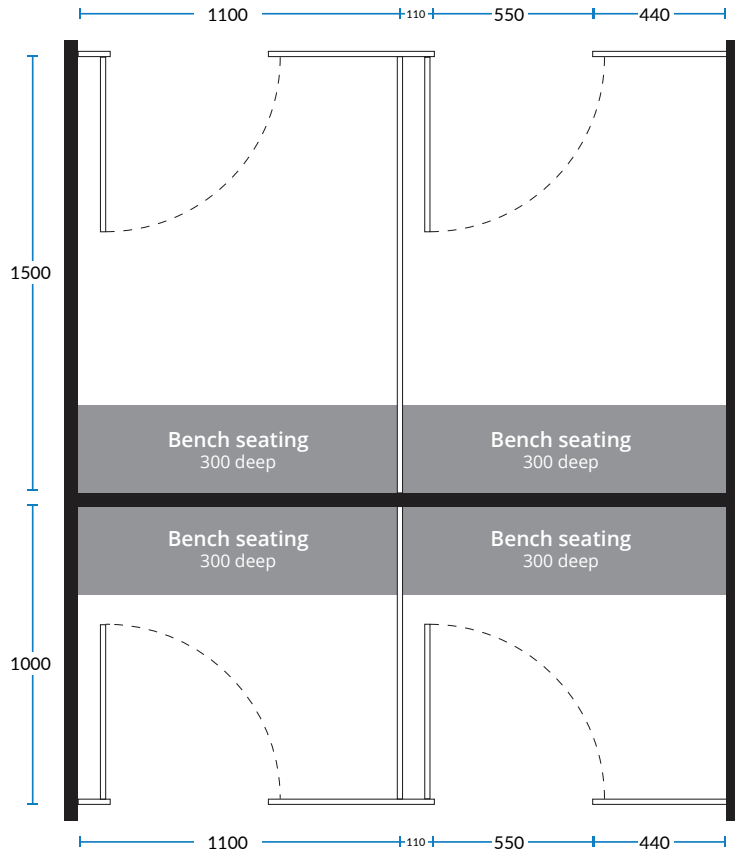

Single person changing cubicles

Family sized changing cubicle



Accessible changing cubicle

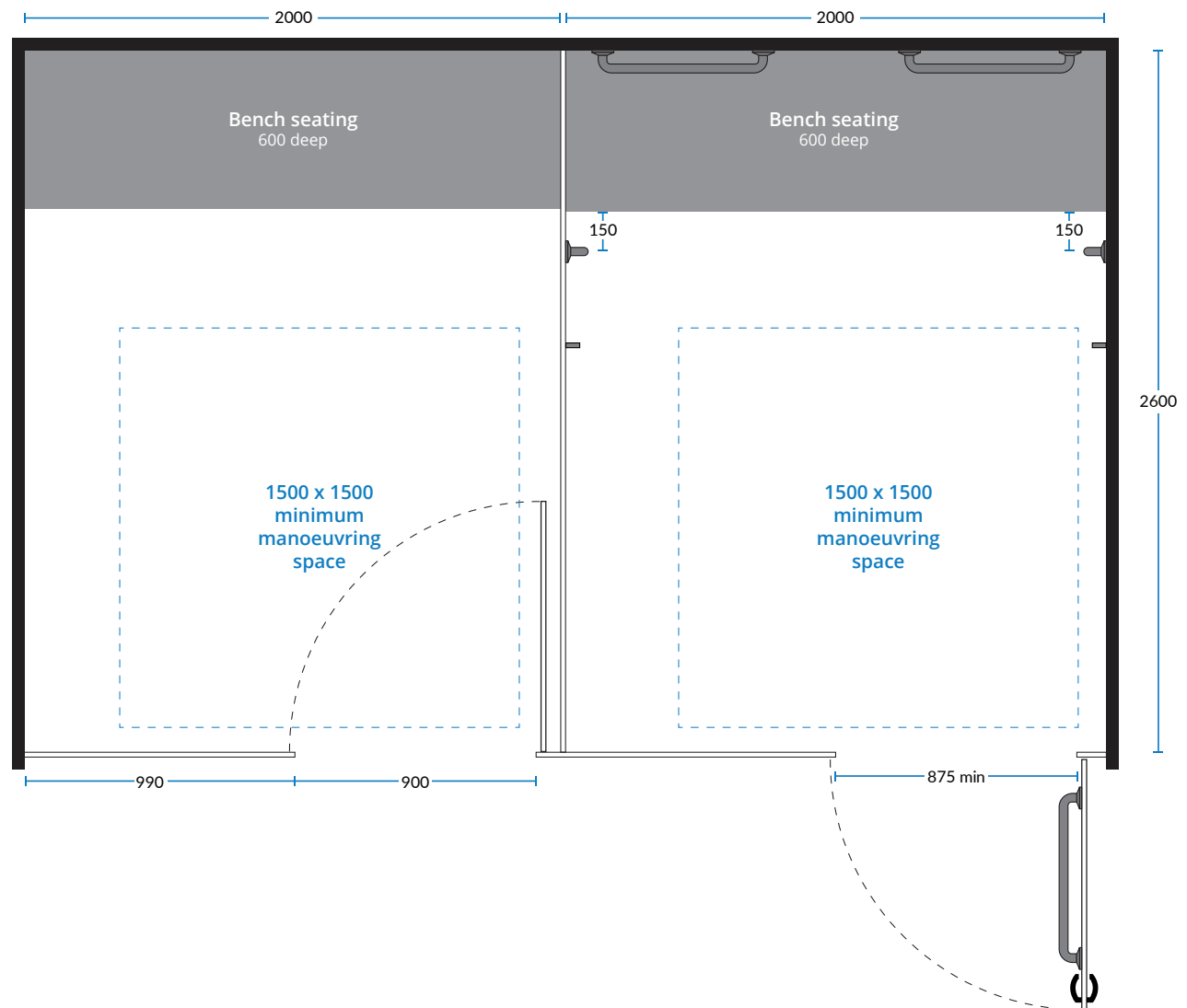

Measurements in mm.  
Diagrams recreated from [Sports England - Swimming Pools](#)

# Accessible Changing Room Sizes

## Unisex Accessible Changing Room

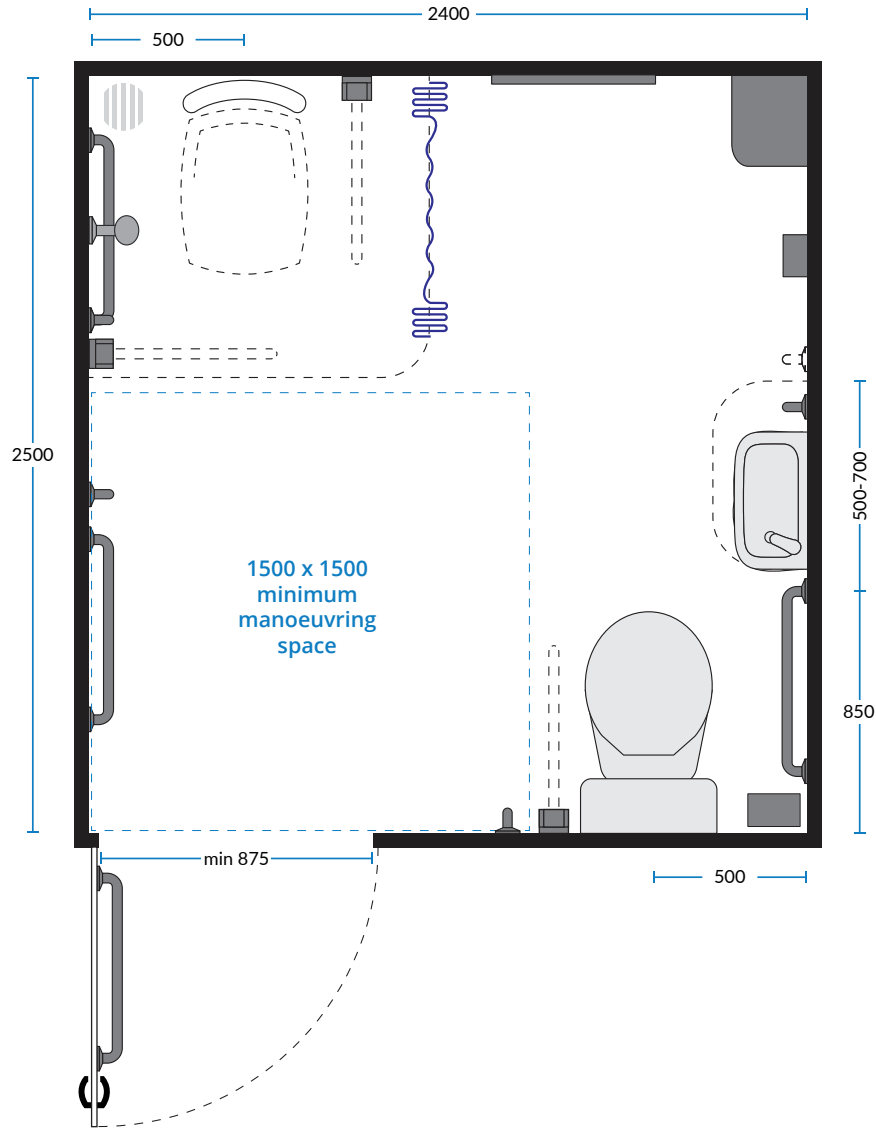

## Unisex Accessible Changing Room with fixed changing bench seat

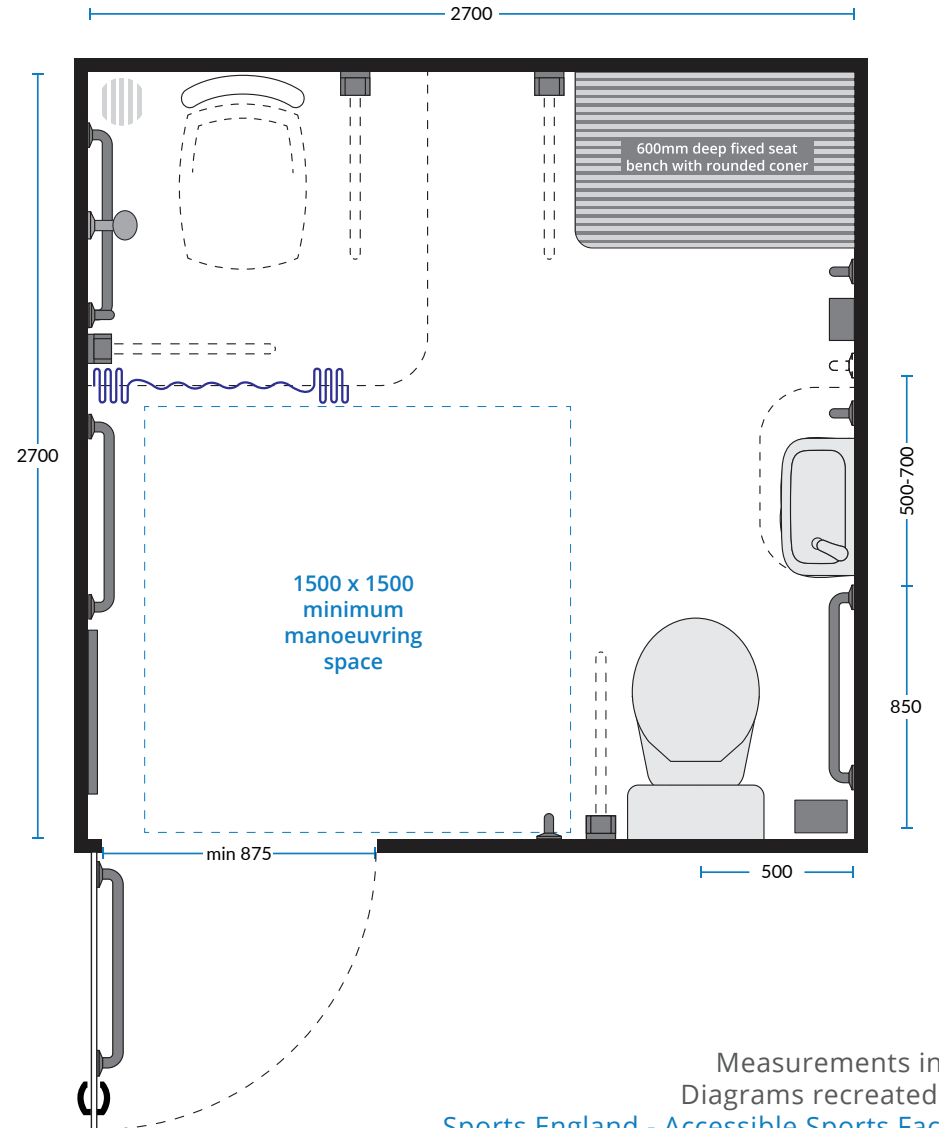

Measurements in mm.  
Diagrams recreated from  
Sports England - Accessible Sports Facilities

# Shower area sizes

## Shower area for general use incorporating changing bench

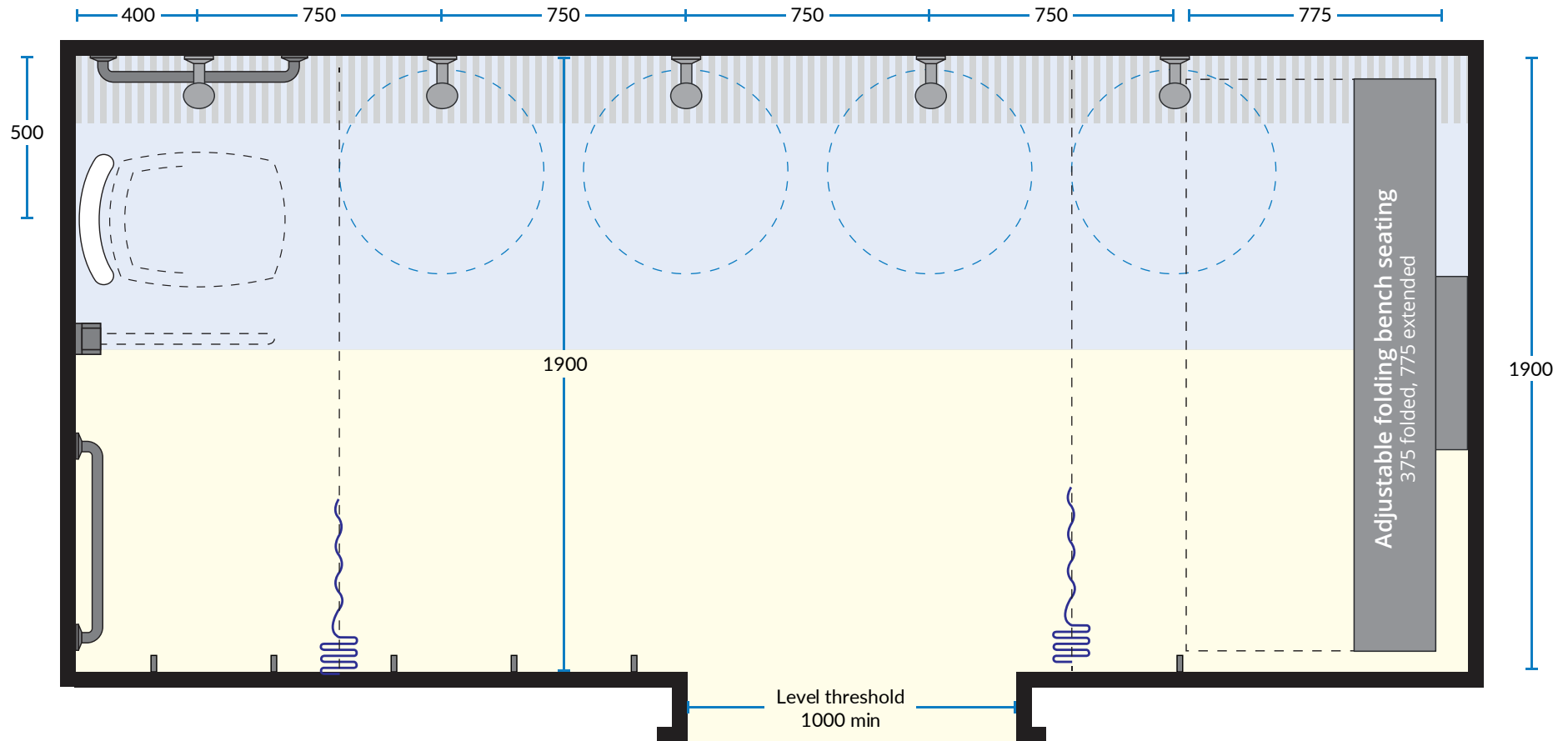

Measurements in mm.  
Diagrams recreated from [Sports England - Accessible Sports Facilities](#)

# Shower sizes

## Communal shower area

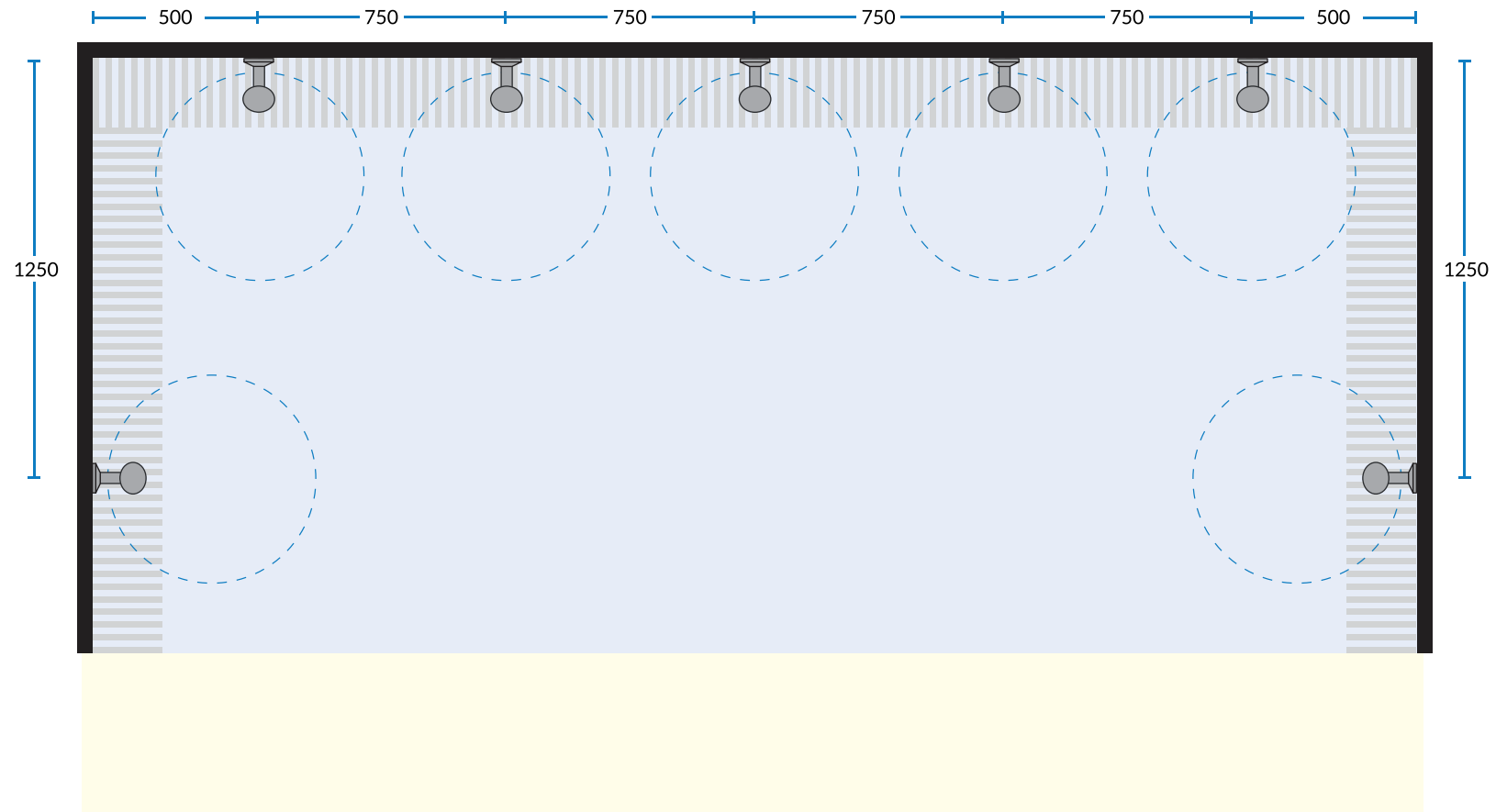

Measurements in mm.  
Diagrams recreated from [Sports England - Swimming Pools](#)



# Shower sizes

## Single person shower cubicles

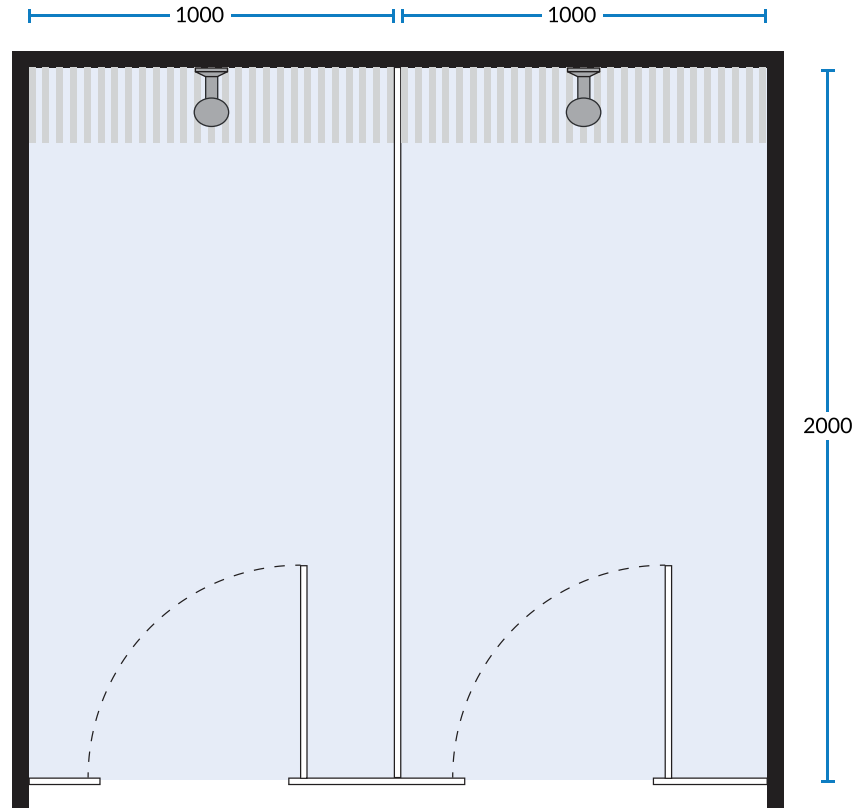

## Disabled shower cubicle

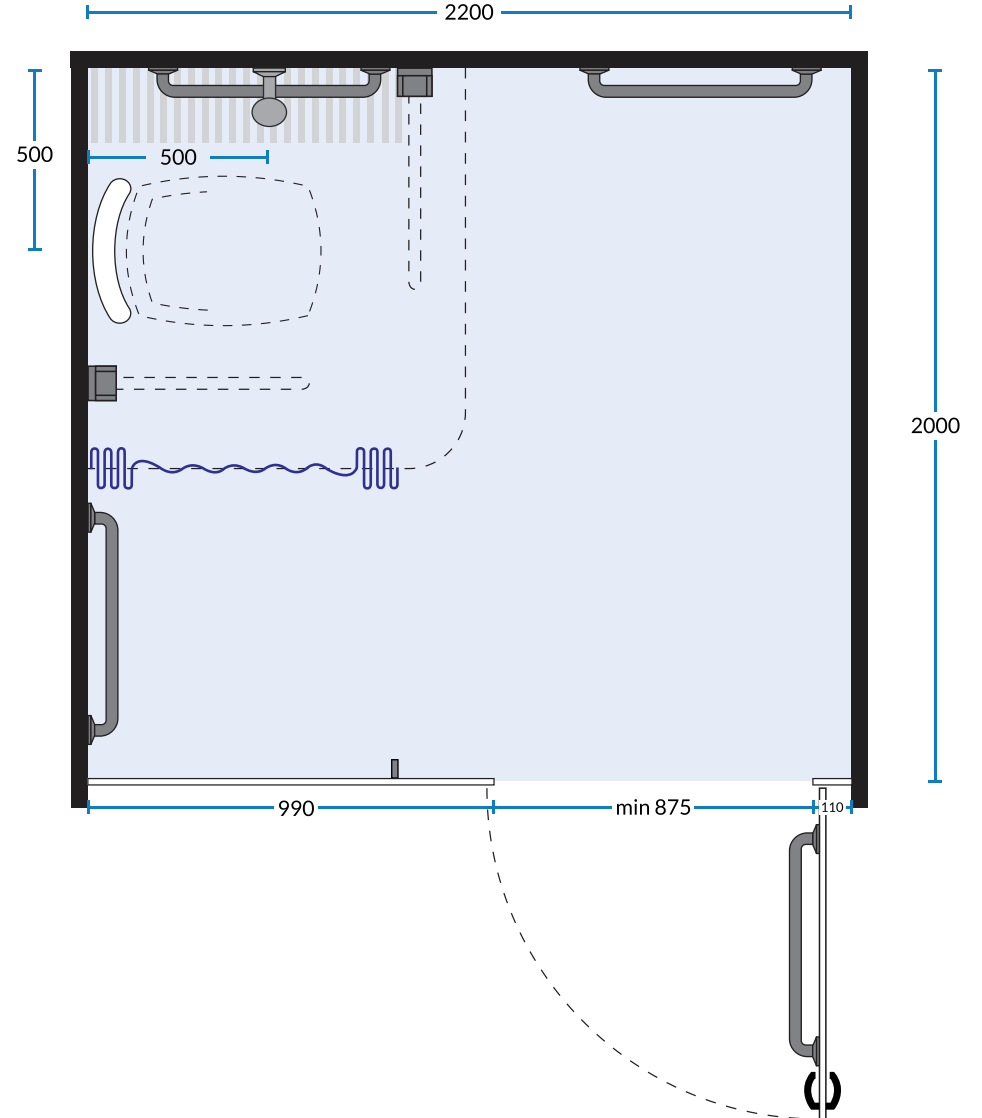

Measurements in mm.  
Diagrams recreated from [Sports England - Swimming Pools](#)

# Sector Washroom Guides

School Washrooms Guide



[Download your free guide](#)

Changing Rooms Guide

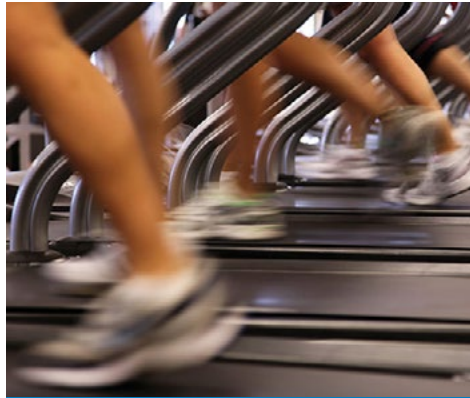

[Download your free guide](#)

Workplace Washroom Guide



[Download your free guide](#)

Camping Washroom Guide



[Download your free guide](#)

Service Station Guide



[Download your free guide](#)

Stadium Washroom Guide



[Download your free guide](#)



[www.washroomcubicles.co.uk](http://www.washroomcubicles.co.uk)

The information in this guide is given in good faith and every effort has been made to ensure its accuracy. Cubicle Centre accept no responsibility for any error or misinterpretation. All liability for loss, disappointment, negligence or other damage caused by reliance on the information contained in this guide is hereby excluded.