

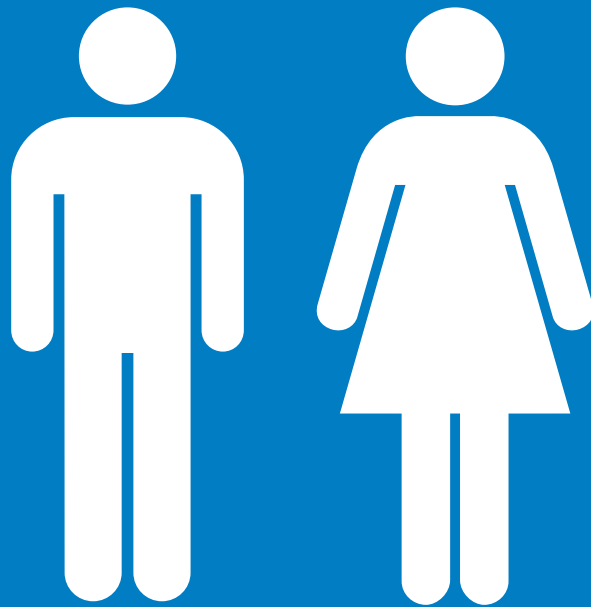

UK Manufacturer of
Toilet Cubicles &
Washroom Systems



cubicle centre

www.washroomcubicles.co.uk

Company Introduction	03	
Cubicle Product Guide	04	
Material Guide	05	
Pendle	06	46
Pendle Junior	07	47
Pennine	09	48
Malvern	10	49
Malvern Plus	11	50
Grampian	13	51
Cairngorm	15	52
Privacy	17	54
Cotswold	19	55
Brecon MFC/HPL	21	56
Brecon CGL	23	56
Sydney MFC/HPL	24	57
Sydney CGL	25	57

Vanity Unit Kits HPL	26	58
Vanity Unit Kits CGL	27	58
Corian Units	29	59
Wall Panel Systems	30	60
Pendle Panel System	31	61
Cistern-Box Kits	32	
Benches	34	
Lockers	35	
Healthcare IPS	36	39
Showerwall	40	
Acrylic Splashbacks	42	
Increased Height WC Cubicles		53
Toilet Cubicle Sizes (Guidelines)	44	
FAQ	62	





Some people think a cubicle is just a cubicle, but we take our business seriously.

The smallest rooms in the building can lead to the biggest frustrations. At Cubicle Centre we are working hard to make your life as easy as possible.

Why Choose Cubicle Centre

For architects and specifiers

- We provide a full library of 2D CAD and 3D BIM (Building Information Modelling) files for all our products
- Specification sheets provide a detailed overview of each product
- Our “Create Specification” tool provides a custom specification in seconds

For contractors and fitters

- Some of the shortest lead times in the industry
- Support throughout the design and build of your project
- Detailed fitting and installation instructions

For the end user

- Excellent quality products (even budget ranges have robust fittings)
- A cubicle range to suit any environment or budget
- Committed to using responsibly sourced wood-based materials

Cubicle Centre is an award winning, family run business that specialises in the manufacture of washroom panel products. We won “SME of the Year” and “Best of the Best” in the Constructing Excellence Awards.

We can also supply sanitary ware, brassware and washroom accessories to complete your project. These products are available to buy online at Plumbware.co.uk (a Cubicle Centre brand).

Not sure which cubicle system is right for you?
Questions about installation, specifications or design?

Contact our friendly team for technical and buying advice:

Tel: (01924) 457 600

Email: sales@washroomcubicles.co.uk

Cubicle Centre
Caldervale Business Park, Ravensthorpe, West Yorkshire, WF13 3JL

Cubicle Product Guide

Fast-Track Pendle Systems

	Price Range	Lead Times* (Working Days)	Material	Fittings	Colours**	Pages Product	Specification
Pendle	Low-Medium	3 - 5	MFC	PVC / SAA	6 options	Pg 06	Pg 46
Pendle Junior	Low-Medium	3 - 5	MFC	PVC / SAA	2 options	Pg 07	Pg 47
Pendle Panels	Low - Medium	3 - 5	MFC	Suspension Fittings	8 options	Pg 31	Pg 61

Made to Measure Cubicles

	Price Range	Lead Times* (Working Days)	Material	Fittings	Colours**	Pages Product	Specification
Pennine	Low	5 - 7	MFC	SAA	5 colours	Pg 09	Pg 48
Malvern	Low-Medium	5 - 7	MFC	SAA (Anti-Vandal)	9 colours	Pg 10	Pg 49
Malvern Plus	Medium	7 - 10	MFC	SAA (Anti-Vandal)	145 colours	Pg 11	Pg 50
Grampian	High	15	HPL	SAA (Anti-Vandal)	160 colours	Pg 13	Pg 51
Cairngorm	Medium - High	10 - 12	CGL	Heavy Duty SAA	144 colours	Pg 15	Pg 52
Privacy	High	10 - 12	CGL	Heavy Duty SAA	51 colours	Pg 17	Pg 54
Cotswold	High	20	CGL	Robust (Powder Coated)	144 colours	Pg 19	Pg 55
Brecon MFC	Medium	10 - 12	MFC	SAA	24 colours	Pg 21	Pg 56
Brecon HPL	High	15	HPL	SAA	160 colours	Pg 21	Pg 56
Brecon CGL	Medium - High	10-15	CGL	Heavy Duty SAA	144 colours	Pg 23	Pg 56
Sydney MFC	Medium	10 - 12	MFC	SAA / Magnetic Catch	24 colours	Pg 24	Pg 57
Sydney HPL	High	15	HPL	SAA / Magnetic Catch	160 colours	Pg 24	Pg 57
Sydney CGL	Medium	10-12	CGL	SAA / Magnetic Catch	144 colours	Pg 25	Pg 57

Vanity Units & Panel Systems

	Price Range	Lead Times* (Working Days)	Material	Fittings	Colours**	Pages Product	Specification
Vanity Unit HPL	Low - Medium	10 - 15	MFC/HPL	Metal Bracket System	7 stock	Pg 26	Pg 58
Vanity Unit CGL	Medium - High	15	CGL	Metal Bracket System	144 colours	Pg 27	Pg 58
Corian Vanity Unit	High	15-20	Corian	Metal Bracket System	60+	Pg 29	Pg 59
Wall Panels	Low - Medium	10 -15	All 3	Suspension Fittings	Matching	Pg 30	Pg 60
Healthcare IPS	Medium - High	20	HPL	Suspension Fittings	10 HPL stock	Pg 36	Pg 39
Healthcare IPS	High	20	CGL	Suspension Fittings	144 colours	Pg 37	Pg 39
Cistern-Box Kits	Low - Medium	10 - 15	All 3	Suspension Fittings	Matching	Pg 32	
Showerwall	Medium	10	MR MDF	Assorted	28 colours	Pg 40	
Splashbacks	Low - Medium	15 - 20	Acrylic	Attachment Adhesive	18 acrylics	Pg 42	

* Lead times may increase during busier periods of the year (I.E. school holidays).

** Colour options are subject to change due to suppliers.

Material Guide

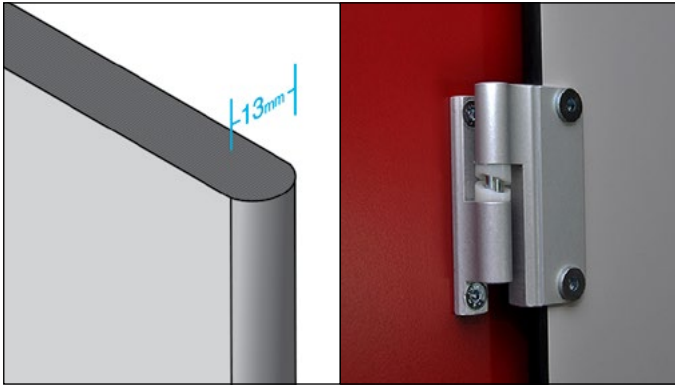

Compact Grade Laminate (CGL)

Constructed from multiple layers of high quality kraft paper, reinforced by thermosetting resins under high pressure and temperature. This produces tough, high density, totally waterproof and hygienic panels that have a high level of strength.

All visible CGL panel edges are machined to a smooth round profile.

CGL is the ideal choice for washroom and changing room areas that have very high traffic.

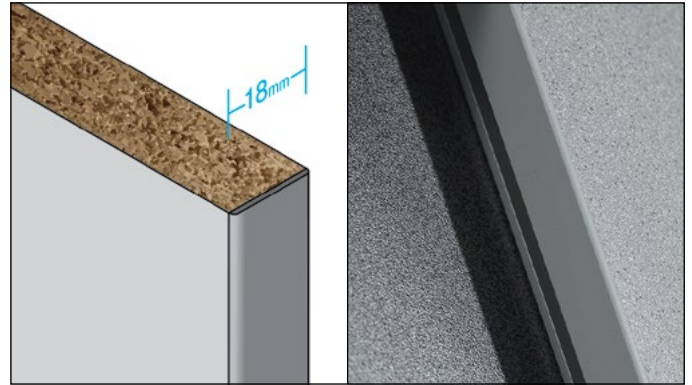

Melamine Faced Chipboard (MFC)

Melamine Faced Chipboard incorporates a decorative melamine surface bonded to both sides of high density chipboard under high pressure and temperature.

All visible MFC panels have impact resistant, PVC edging applied.

MFC is a cost effective, hygienic and lightweight solution for all non-wet toilet areas.

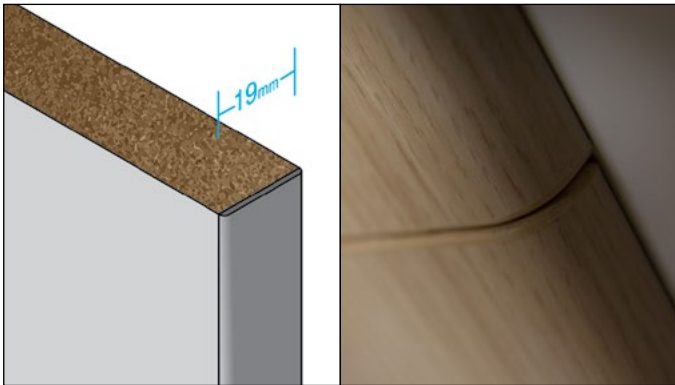

High Pressure Laminate (HPL)

Constructed from layers of high quality kraft paper, reinforced by thermosetting resins under high pressure and temperature with one decorative surface. The result is a hygienic 0.8mm thick flexible sheet material.

HPL is bonded onto a high density coreboard to produce a strong finished panel. Panels can be post-formed to create a seamless, curved edge detail.

HPL is suitable for use in areas of high traffic and reasonably demanding conditions.

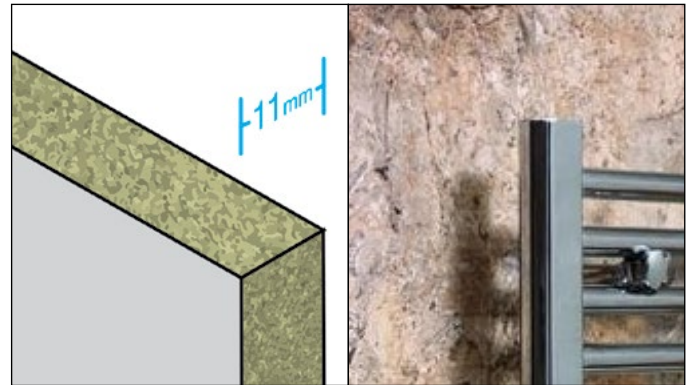

Showerwall

All decors from the Marble, Quarry and Mineral collections are manufactured from a moisture resistant MDF core and finished with a high pressure laminate (HPL), creating 10.5mm thick panels.

These panels are available in 3 widths. 600mm, 900mm or 1200mm; and are 2440mm in height. You can choose from square cut panels or take advantage of the Proclick technology which achieves seamless joints without the need for joining trims.



Three enclosed cubicles requires - x3 Box A (Door Pack) and x2 Box B (Partition Pack)

Pendle

Specification: [Page 46](#)

A box packed toilet cubicle system suited for all dry areas. Comprising of Box A (Door Pack) and Box B (Partition Pack), containing all necessary panels and fittings.

Usually dispatched within 48 hours of receipt of order

Box packed for ease of transport and handling

Adjustable on-site

Durable panels with tough PVC edging

Smoke Blue, Stone Grey, Grey, Plain Grey, White or

Woodgrain Options



Indicator Face



Cubicle Leg



Cubicle Latch



Full-Height Hinge



Two enclosed cubicles requires - x2 Box A (Door Pack) and a Box B (Partition Pack)

Pendle Junior

Specification: Page 47

A box packed toilet cubicle system suited for Junior school washrooms. Comprising of Box A (Door Pack) and Box B (Partition Pack), containing all necessary panels and fittings.

Usually dispatched within 48 hours of order

Box packed for ease of transport and handling

Adjustable on-site

Durable panels with tough PVC edging

Two door colour options - Blueberry or Dragon Fruit (above)

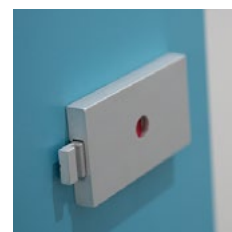

Indicator Face



Cubicle Leg

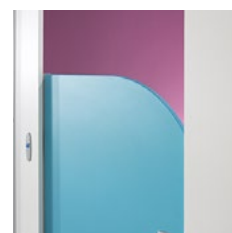

Curved Door



Full-Height Hinge

Pennine cubicles offer a level of durability not normally associated with a budget range.

Brackets and hinges are through-bolt types that provide a strong and secure cubicle fixing.





Pennine

Suited for use in dry areas where function and price are the most important factors. Pennine offers all the key functional qualities required for a practical washroom environment.

Budget range

Fast-Track delivery

Melamine Faced Chipboard (MFC)

Solid PVC edging

Available in Speckled or Plain Grey, Speckled Anthracite, White or Cream

Specification: Page 48

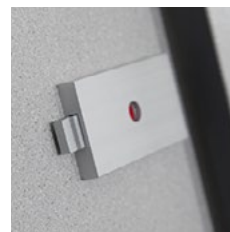

Indicator Face



Cubicle Leg



Cubicle Latch

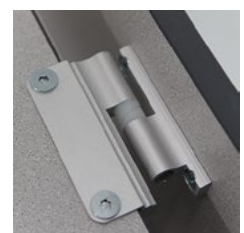

Hidden Safety Hinge



Plain Grey Panels with Blue Doors
Speckled Anthracite Vanity Top with Plain Grey Panels

Malvern

Specification: Page 49

Developed for the refurbishment market, Malvern cubicles consist of durable panels and tamper proof fittings. We can dispatch custom-made cubicles within 5 to 10 working days thanks to smart stocking and fast custom manufacturing.

Fast-Track delivery

Melamine Faced Chipboard (MFC)

Tough PVC edging (Light Grey)

Anti-vandal cubicle fittings

Choice of 9 colour options for cubicle doors



Indicator Face



Adjustable Cubicle Leg

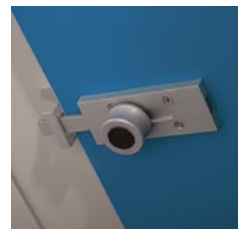

Cubicle Latch

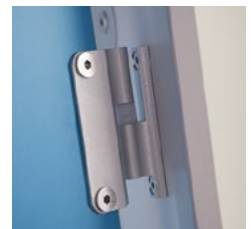

Hidden Safety Hinge



Choose from over 100 colours online

Malvern Plus

Specification: Page 50

To the same specification as Malvern, this cubicle system offers anti-vandal cubicle fittings and a wide colour choice as standard.

Made to measure

Melamine Faced Chipboard (MFC)

Matching PVC edging

Anti-vandal cubicle fittings

Choice of over 100 colours

Available in an increased height configuration (See page 53)



Indicator Face



Adjustable Cubicle Leg



Plaster Bracket



Secure Hinge Face Plate



A tough cubicle system suited for areas of high traffic and reasonably robust conditions - manufactured using High Pressure Laminate.

See pages 30 and 60 for details on Wall Panels Systems.



Grampian

A robust cubicle system with panels manufactured from High Pressure Laminate (HPL) bonded onto high density coreboard.

Made to measure

High Pressure Laminate (HPL)

Post-Formed pilasters available @ extra cost

Anti-vandal cubicle fittings

147 colours available

Available in an increased height configuration (See page 53)

Specification: Page 51

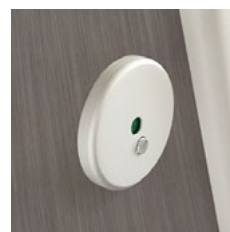

Indicator Face



Adjustable Cubicle Leg



Secure Hinge Face Plate

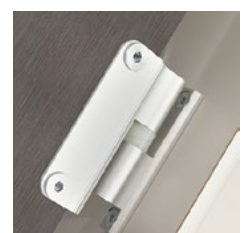

Hidden Safety Hinge



A tough, vandal resistant cubicle system designed for areas of high traffic - manufactured using **Compact Grade Laminate**. See pages 52 for full specification



Cairngorm

Specification: Page 52

Designed to perform in even the most demanding environments, Cairngorm cubicles are vandal resistant and completely waterproof. Manufactured from Compact Grade Laminate - a waterproof and hygienic product that has a high level of strength.

Cairngorm cubicles are supplied with heavy duty fittings which are through-bolted on site for increased stability.

Made to measure

Compact Grade Laminate (CGL)

Suited for use in shower areas

Heavy duty fittings

Available in an increased height configuration (See page 53)

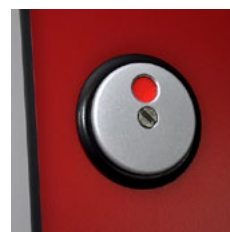

Indicator Face



Wide Base Cubicle Leg

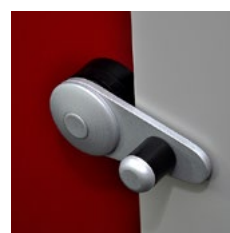

Robust 'Single Action' Latch

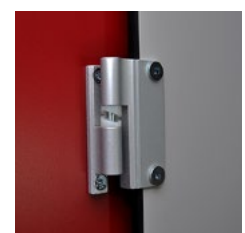

Hidden Safety Hinge



A full-height design manufactured from **Compact Grade Laminate** framed and secured with full length channel fittings.



Full height cubicles with matching vanity units

Privacy

Specification: Page 54

For the ultimate in washroom privacy look no further. Durability combined with a functional, clean design make this full-height WC cubicle system a winning formula for modern commercial washrooms.

Made to measure

Full-height system

Compact Grade Laminate (CGL)

Heavy-duty fittings - no fixings visible from exterior

Wide colour choice



Indicator Face

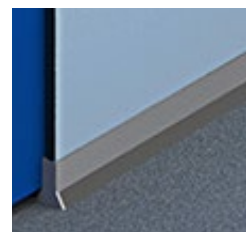

Floor Channel



Robust 'Single Action' Latch



Hidden Safety Hinge

Cotswold cubicles are supplied with sub-assembled fittings saving you time and money on-site.

No fixings are visible from the exterior of the cubicle.





Compact Grade Laminate Panels - Oak

Cotswold

A combination of style and durability, Cotswold is perfect for areas of high volume usage with a robust build quality proven to meet everyday demands.

Made to measure

Compact Grade Laminate (CGL)

Also available in Melamine Faced Chipboard (MFC)

Fully framed system

No fixings visible from exterior

Wide colour choice

Specification: Page 55

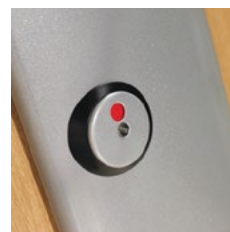

Indicator Face



Wide Base Cubicle Leg

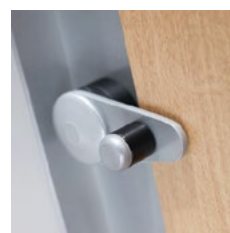

Robust 'Single Action' Latch



Hidden Safety Hinge



The Brecon range is the most popular choice for junior schools.

Choose from square, arch, or reverse-curve door profiles, and from a range of vibrant colours – Blueberry, Mango and Dragon Fruit are popular options.



Blue Panels with Dragon Fruit Doors

Brecon MFC/HPL

Specification: Page 56

Combining creativity with added safety features, Brecon is the preferred choice of cubicle system for Junior school washrooms.

Made to measure

Melamine Faced Chipboard (MFC)

High Pressure Laminate (HPL)

Anti-trap hinges and latches

SAA fittings

Bright selection of MFC and HPL colours

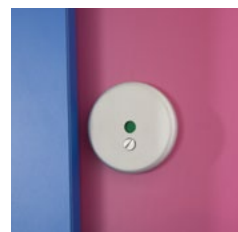

Indicator Face

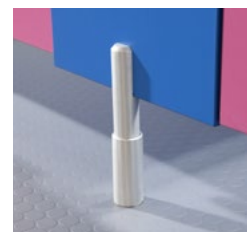

Adjustable Cubicle Leg

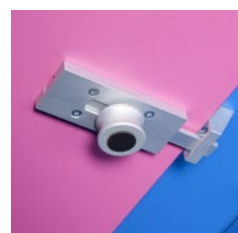

Cubicle Latch



Hidden Safety Hinge

All the great features of the Brecon junior school cubicles, but with some added brawn.

Compact Grade Laminate (CGL) panels teamed up with durable fittings mean your cubicles should never be out-of-order.



Compact Grade Laminate (CGL) panels

Brecon CGL

Specification: Page 56

With all the playful options of the standard Brecon cubicle system, **Brecon CGL** is a real tough cookie suited for children's washrooms requiring a little extra muscle.

Made to measure

Compact Grade Laminate (CGL)

Anti-trap hinges and latches

Heavy duty fittings

Wide colour choice

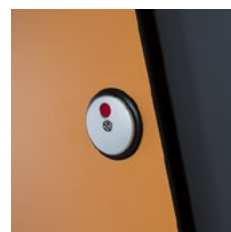

Indicator Face



Wide Base Cubicle Leg

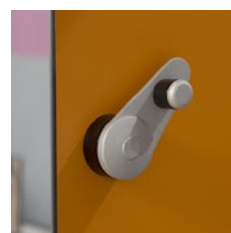

Robust 'Single Action' Latch



Hidden Safety Hinge



Sydney MFC/HPL

Specification: Page 57

A lively and fun way to introduce young children to toilet cubicles and the washroom environment.

Secure floor supports deliver a sturdy and safe cubicle system suited for any nursery / infant school washroom.

Made to measure

Melamine Faced Chipboard (MFC)

High Pressure Laminate (HPL)

Overall height of 1500mm with 100mm floor clearance

Anti-trap hinges with magnetic door catch

Same colour selections as Brecon range

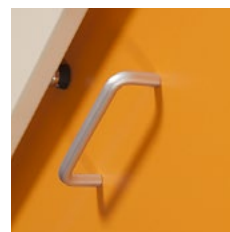

Child-Friendly Handle



Floor Supports



Magnetic Door Catch

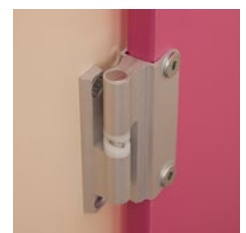

Hidden Safety Hinge



Sydney CGL

Specification: Page 57

Perfect for a EYFS or day nursery setting. All the child friendly design of Sydney, but with durable and water resistant panels. Slamming doors and splashed water are no trouble for these tough cubicles.

Made to measure

Compact Grade Laminate (CGL)

Overall height of 1500mm with 100mm floor clearance

Anti-trap hinges with magnetic door catch

Wide colour choice

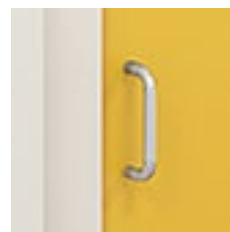

Child-Friendly Handle



Floor Supports



Unique Curved Design



Hidden Safety Hinge



HPL Vanity Units

Specification: Page 58

Vanity Units are made to measure and available as either Inset (550mm deep) or Semi-Recessed (350mm deep) options. Overall vanity height is 850mm (standard) - this can be altered to suit your individual requirements.

Vanity tops are 20mm thick with a High Pressure Laminate (HPL) finish as standard. Under panels are constructed from high performance MFC as standard or Compact Grade Laminate if specified..

Made to measure

Supplied in kit form for self assembly

HPL top material | MFC/CGL Underpanels

Choice of inset or semi-recessed designs

Unique design removes need for timber frame

Colour choice to match your cubicles



Banian Noirci top with Banian Bianchi under panels

CGL Vanity Units

The same specification as the standard vanity unit, but made from water-resistant and durable Compact Grade Laminate (CGL) panels.

The ideal option for high usage areas.

Made to measure

Supplied in kit form for self assembly

CGL panel material

Choice of inset or semi-recessed designs

Unique design removes need for timber frame

Colour choice to match your cubicles

Specification: Page 58

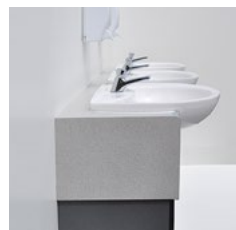

Semi-Recessed Vanity Unit



Curved Aluminium Front Edge

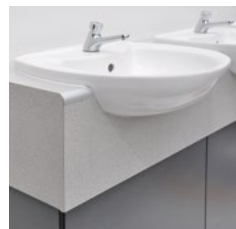

Matching Colour Choice

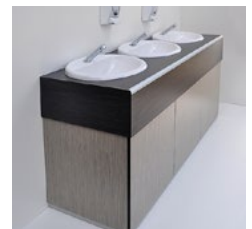

Made-to-Measure

New

Solid Surface Vanity units



Solid Surface vanity units offer an alternative to a traditional vanity. Its versatility means it can be used as a basin surface to mount your choice of basin, or as an all in one trough solution.

Corian is non porous and hygienic making it an ideal material for washrooms. Its smooth surface repels liquids making it easy to clean - bacteria and mould have nowhere to take root. The surfaces are renewable and inherently environmentally friendly. Stains and scratches can be removed without a trace, simply by rubbing with household cleaner.

Available in a wide range of colour finishes, Corian surfaces are jointed with colour-coordinated joint adhesive with inconspicuous seams resulting in a smooth surface enabling large designs made from a single element. Whether you want a single wash unit, or a multi-user unit, Corian offers a beautiful seamless solution.



Glacier White top with Chene D'Argent under panels

Solid Surface Vanity units

Specification: Page 59

Due to its versatility, Corian vanity units can be made to your absolute specification. Call us to discuss your requirements

Made to measure

Corian® acrylic resin and mineral composite

Multiple basin or trough options

Timber frame required

Wide range of colour choices



Corian trough unit shown mounted onto a storage unit



Wall Panel Systems

Full-height wall panel systems can be supplied to match your cubicle colour configuration and material.

For areas prone to a wet environment, such as changing rooms, Cubicle Centre can supply CGL wall panel systems.

Panels come flat-packed, complete with all flash-gap material and suspension fitting components.

Overall system height varies according to your ceiling height.

See page 60 for specification details.



Timber frame supplied by other

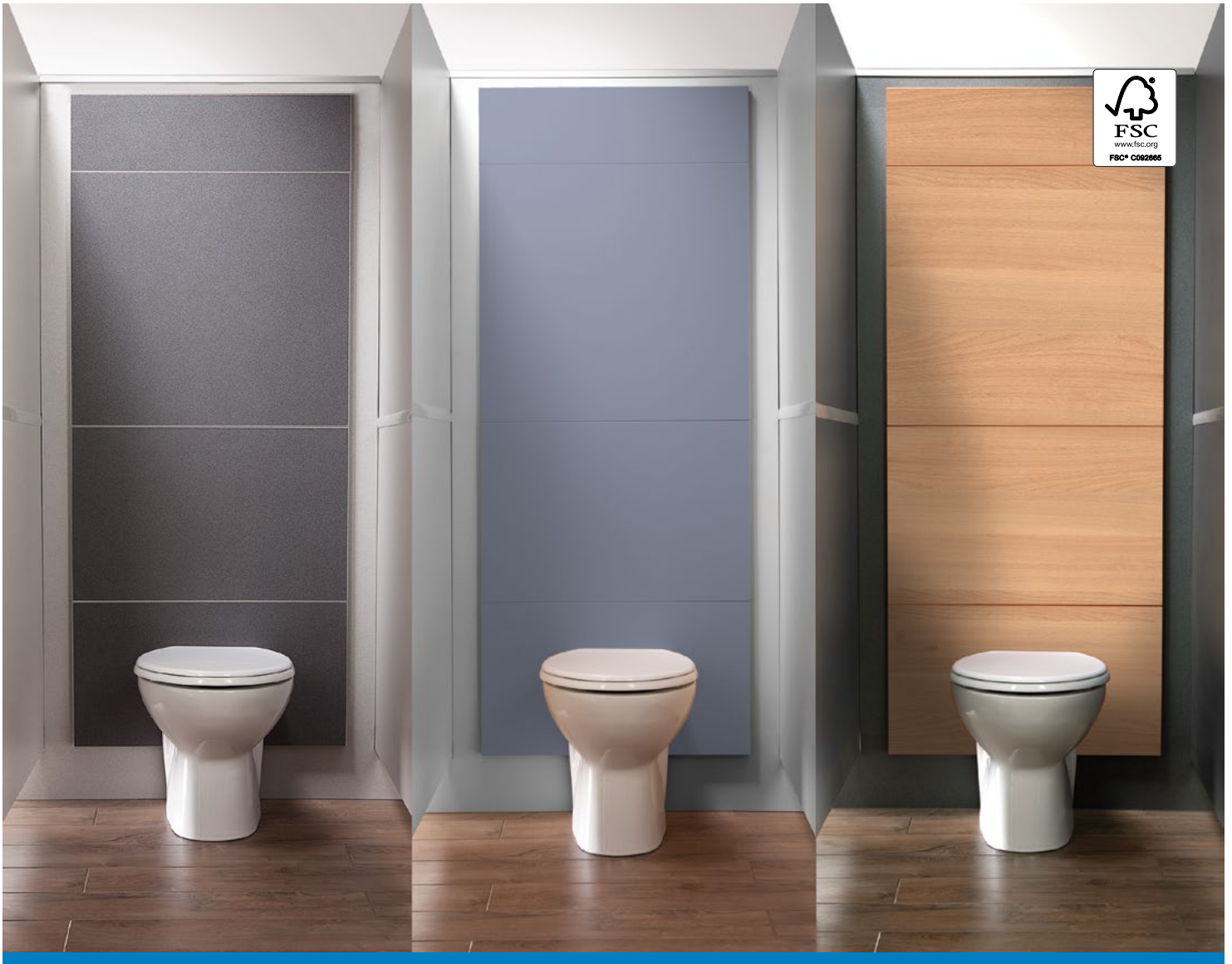

Pendle Panels

Simple to specify, delivered to you quickly and easily adjusted and installed on-site.

The Pendle washroom panel system has been developed for both urinal and WC panel configurations.

With an overall height to match Pendle cubicles (1950mm), this box packed panel system can be cut-to-size on site to fit various cubicle widths up to a max. of 1200mm.

Pendle Junior panels are available in Blueberry and Dragon Fruit.

Pendle products can be supplied as FSC certified on request.

Specification: page 61

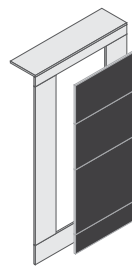

Grey

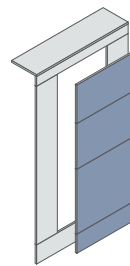

Smoke Blue



Woodgrain

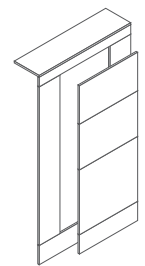

White

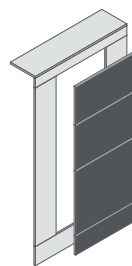

Stone Grey

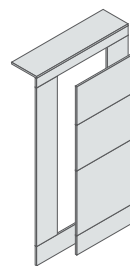

Plain Grey

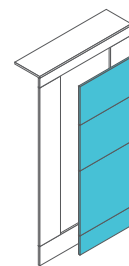

Blueberry

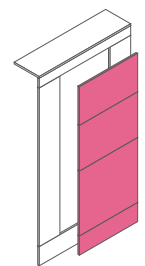

Dragon Fruit



Cistern-Box Kits

Cistern-Box or 'half-height' kits are available as an alternative to the full height option.

Available in MFC, HPL and CGL, Cistern-Box Kits measure 1200mm (high) x 300mm (deep) as standard, and fit your internal cubicle width(s).

This product can also be manufactured to suit your individual site requirements, simply provide us with your measurements.

Timber frame supplied by others.

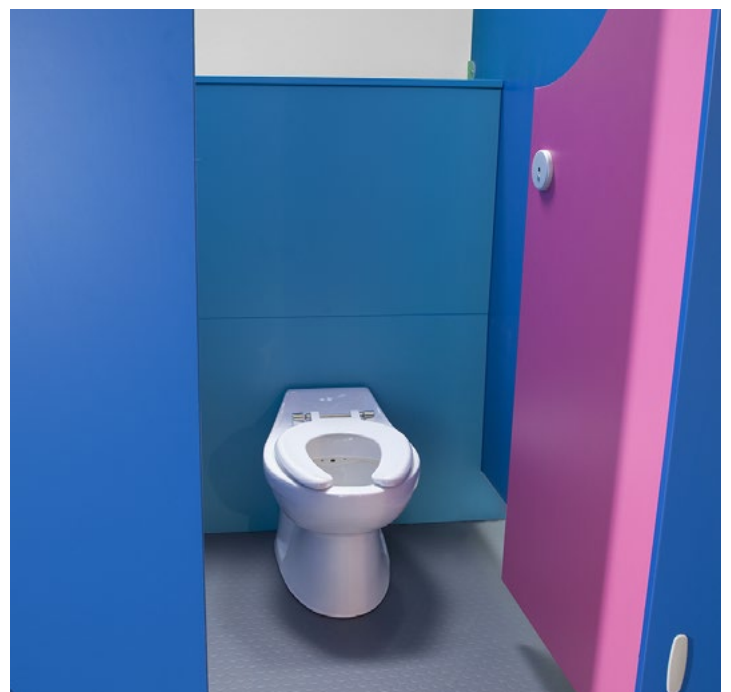



New



Benches

For a complete changing room area, Cubicle Centre can now supply made to measure bench seating systems.

Made to measure

Beech Slats

Compact Grade Laminate (CGL) Solid Tops

Various configurations available

Square steel tube frame construction

Grey (RAL 9006) or Black (RAL 9005) frames



Single Island

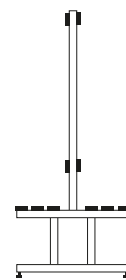

Double Island



Single

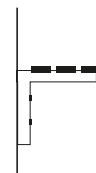

Cantilever



Wall/Floor mount



Lockers

Lockers have been designed to complement any washroom and are robust and hardwearing. Lockers feature Solid Grade Laminate doors and shelves available in a wide variety of colours each with complementary framework in aluminium. Ideal for any washroom or cubicle system in both wet and dry environments.

Camlock and hasp and staple are standard locks. Coin return/retain, combination and digital locks can be supplied on request.

Contact us on 01924 457600 to discuss your requirements and to obtain a quote.

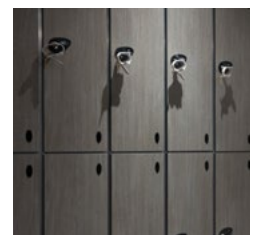
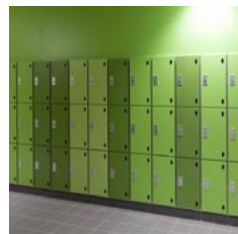



Healthcare IPS HPL /CGL

Standard Pre Assembled Boxed Unit

Cubicle Centre's boxed Healthcare panel systems are ideal for refurbishment or additional works projects because they provide the least disruption due to their fast installation.

These units project out from the finished wall surface to provide a self contained duct - the plumbing is concealed behind the whole unit with easy to access doors which can be hinged or lockable. Boxed kits do not require any alterations to existing structures provided they are fitted to existing structural or partition walls. Units are available as full height or shelf height assemblies.

Specification: Page 39

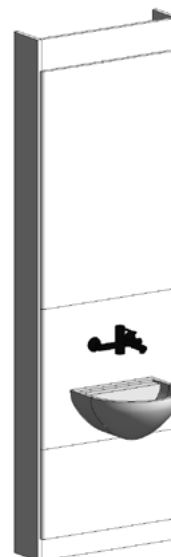



Healthcare IPS HPL/CGL

Standard Pre Assembled Recessed Unit (Plywood Frame)

In a new build project where a service duct can be constructed within the partition wall, our recessed frame units will fit directly into the drywall apertures creating a flush panel solution. This offers a space-saving and aesthetically pleasing finish.

With some additional work, these panels can also be cut into existing partition walls by a competent builder/joiner. These units are typically full height with panels fixed with keku clips as standard and/or hinges and locks supplied as extra.

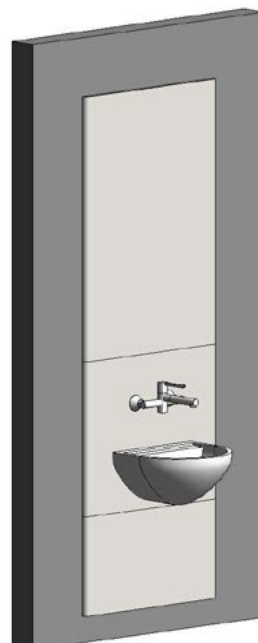

Specification: Page 39

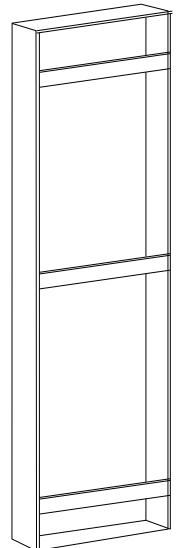

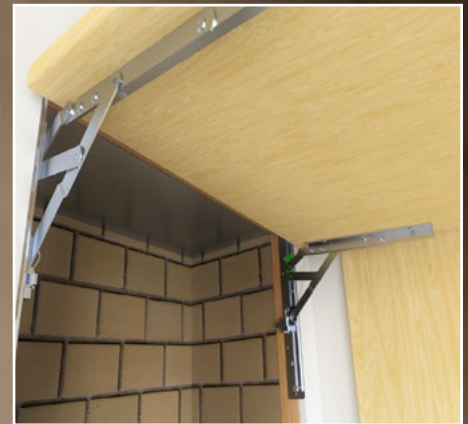

Hinges and Locks

Integrated Plumbing Systems are available with additional options for hinged and lockable panels.

For 13mm CGL panels we offer a side and top opening hinge from Vela, or the Grass Tiomos concealed cup hinge from Häfele, and a Cylinder cam lock, also from Häfele.

18mm HPL panels are specified with either Vela side and top opening hinges or Häfele concealed cup hinges. For HPL panels, Häfele rim locks are specified.



Grass Tiomos Hinge (13mm)



Häfele Concealed Cup Hinge (18mm)



Häfele Cylinder Cam Lock (13mm)



Häfele Rim Lock (18mm)

A complete IPS panel system fully compliant with NHS Estate Guidelines and HBN 00-10 Parts A, B and C specifications.

Standard Pre Assembled Boxed Unit

- Panels** High Pressure Laminate (with post-formed edges)
Compact Grade Laminate
- Depth** 200mm standard + 18mm (HPL) /13mm (CGL) front panels
- Height:** Bottom panel 430mm
Middle panel 670mm
Top panel variable height to suit
(Aluminium extrusion fitted to all vertical edges of box structure)

Standard Pre Assembled Recessed Unit with Plywood Frame

- Panels** High Pressure Laminate (with post-formed edges)
Compact Grade Laminate
- Depth** 18mm (HPL) / 13mm (CGL)
- Height:** Bottom panel 430mm
Middle panel 670mm
Top panel variable height to suit

Panels supplied with keku clips or hinges and locks as required. Panel heights manufactured to customer specification.

Colours Available

Standard colours

<https://www.washroomcubicles.co.uk/standard-hpl-healthcare-colours/>

To see the full range

www.washroomcubicles.co.uk/compact-grade-laminate/

www.washroomcubicles.co.uk/high-pressure-laminate/

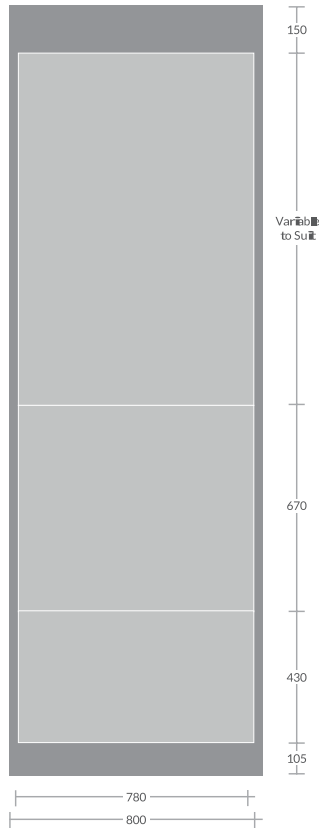

Standard Pre Assembled Boxed Unit

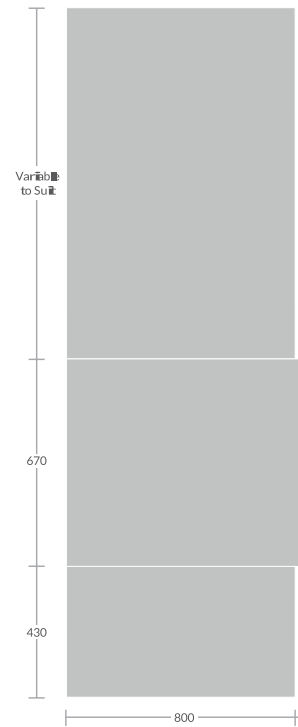

Standard Pre Assembled Recessed Unit

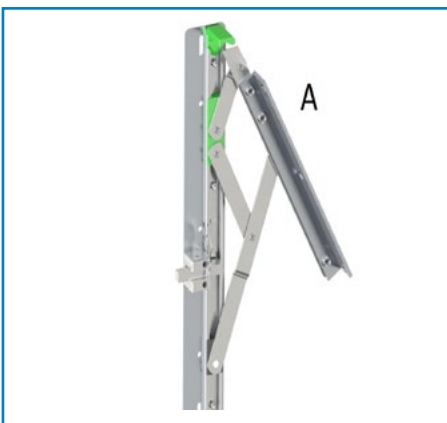
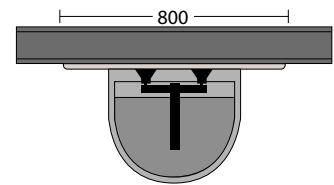
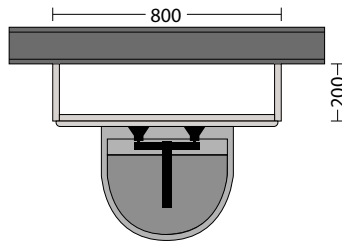

Vela top opening Hinge with Automatic Safety Catch

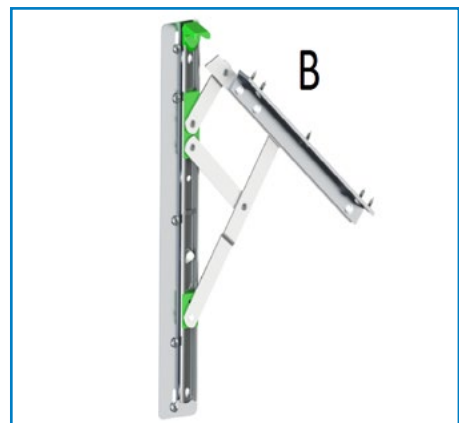
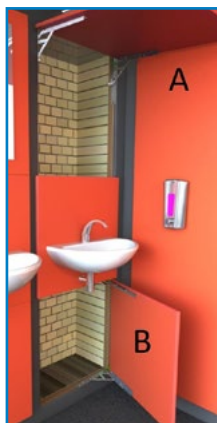

Vela Side Opening Hinge



Mocha panels from the Acrylic range

Showerwall

Showerwall offers a cost effective alternative to tiling a washroom. The panels are 11mm Moisture Resistant MDF with virtually seamless clickfit technology which, when sealed, is perfect for wet locations.

Quick to install, more hygienic and very little maintenance required once fitted. The panels are adjustable on site to suit your requirements. Available in our range of standard and premium colours (www.washroomcubicles.co.uk/shower-panels/).

Orders are delivered with the following:

- Shower Panels to three size options (see opposite)
- Choice of Channel finishes
- White Shower Seal Channel
- Adhesive and Silicone

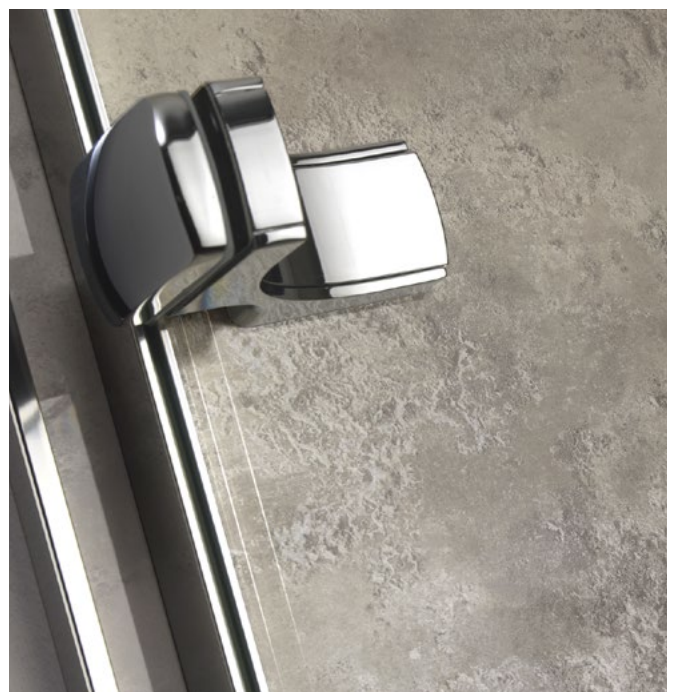

Showerwall Shower Panel

Uniclass 1.4 L516
Uniclass 2015 Ss_25_25_45_25

NBS Create 25-85-45/120
Keynote K32/140



Manufacturer

Showerwall
+44 (0)1924 457600
design@washroomcubicles.co.uk

Available Downloads

FITTING INSTRUCTIONS
.pdf format

Product reference Showerwall
Material Moisture Resistant MDF

Standard Panel Sizes

1200mm x 2400mm
900mm x 2400mm
600mm x 2400mm

Fittings

Internal Corner Channel
End Channel
"H" Connecting Channel
White PVC Seal Channel

Panel colour

Standard and Premium colours available. See link below

Framing

Black, White, Chrome or Satin Silver Channels

Colour

Standard & Premium options
www.washroomcubicles.co.uk/shower-panels/

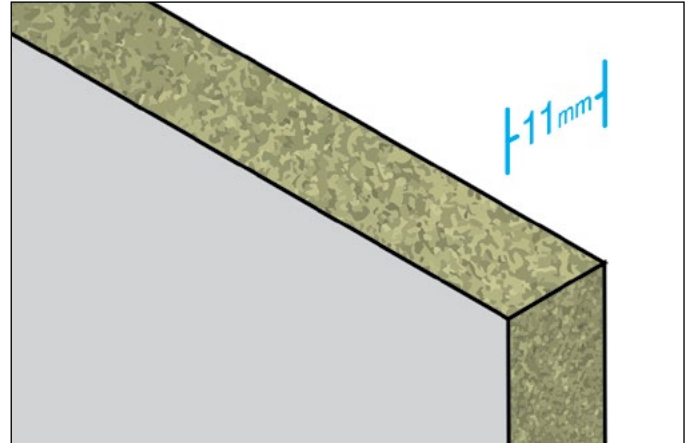

Moisture Resistant MDF

Moisture Resistant (MR) Medium-density fibreboard (MDF) is an engineered wood product made by breaking down hardwood or softwood residuals into wood fibres and combining it with wax and a resin binder, and forming panels by applying high temperature and pressure.

Once the edges are properly sealed the panels are ideal for wet room locations.

Showerwall end trims

The system comes with two key components which ensure a watertight seal for Showerwall products; available in a range of colours to suit every decor. Easy to install and maintain.

Five trims are available dependant on where you would like to fit the panels. Note: all trims measure 2450mm in length and should be sealed using Showerwall sealant.



Sureseal



Silicone & Adhesive

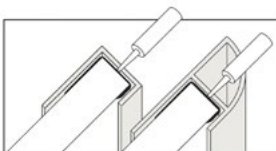

Showerwall End Cap

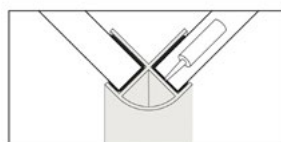

Showerwall External Trim

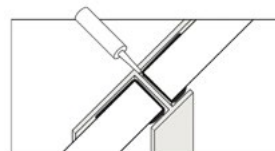

Showerwall Join Trim

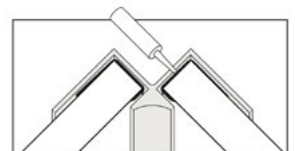

Showerwall Internal Trim



Banian Noirci vanity top with Morello Cherry Splashback

Acrylic Splashbacks

Acrylic splashbacks are beautiful and tough. The acrylic glass is 4mm thick with a back painted surface available in a range of colours. This gives a fantastic colour intensity and reflection through its surface, just like coloured glass.

Our acrylic panels are an affordable alternative to glass and ceramic tiles. The highly durable panels are 25 times more impact resistant than traditional glass. So it will not shatter.

It also has a high heat resistance of up to 100°C. The material is also 100% waterproof, so ideal for the washroom environment.

Acrylic Glass Summary

- Cost-effective glass alternative
- 100% waterproof
- Panels can be cut on site
- Scuffs can be polished away
- High heat resistance
- Will not shatter
- Less energy to produce than glass
- Material can be recycled
- Fantastic colour intensity
- Looks like traditional coloured glass

Guidelines and Specifications



NBS Source
PARTNER



specifiedby
a product of **CAUSEWAY**

bimstore

Toilet Cubicle Sizes (Universal Access Guidelines)

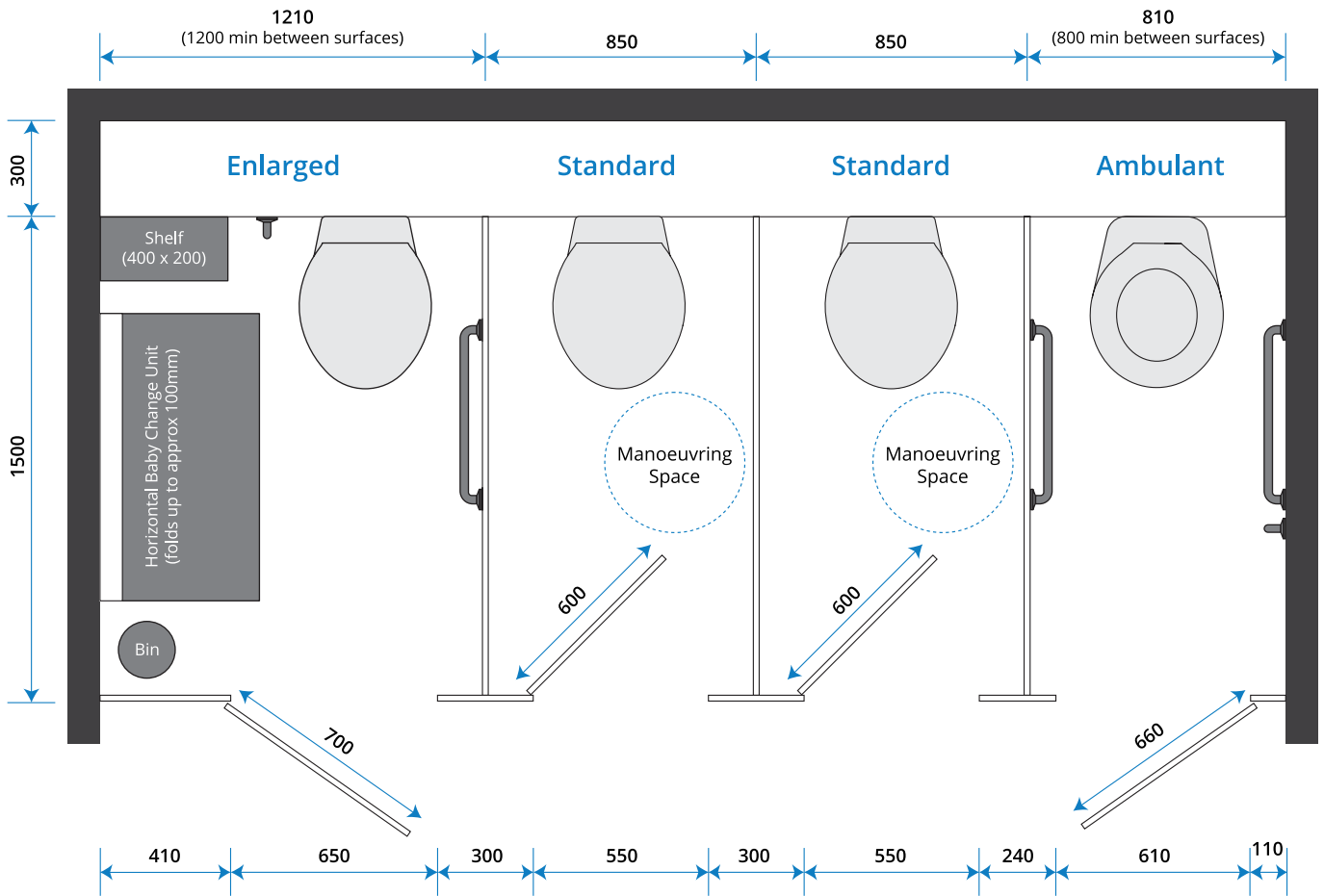

Enlarged WC Cubicles:

Where there are 4 or more cubicles in a washroom, one of these must be an enlarged cubicle.

Enlarged cubicles must be a minimum width of 1200mm and include an outward opening door.

A horizontal and vertical grab rail set is required around the WC.

Standard Toilet Cubicles:

All standard cubicles must now have a minimum of 450mm diameter manoeuvring space within the cubicle.

Indicator-bolts must be capable of being operated with a closed fist (single action) - and doors must allow for emergency access should the user collapse and become trapped in the cubicle.

Ambulant Disabled Cubicles:

Every same-sex washroom must have at least one wc cubicle that is suitable for the ambulant disabled.

If there is only one cubicle in the washroom this must be suitable for an ambulant disabled person.

The ambulant disabled cubicle must include an outward opening door.

Wheelchair Accessible Cubicle Dimensions

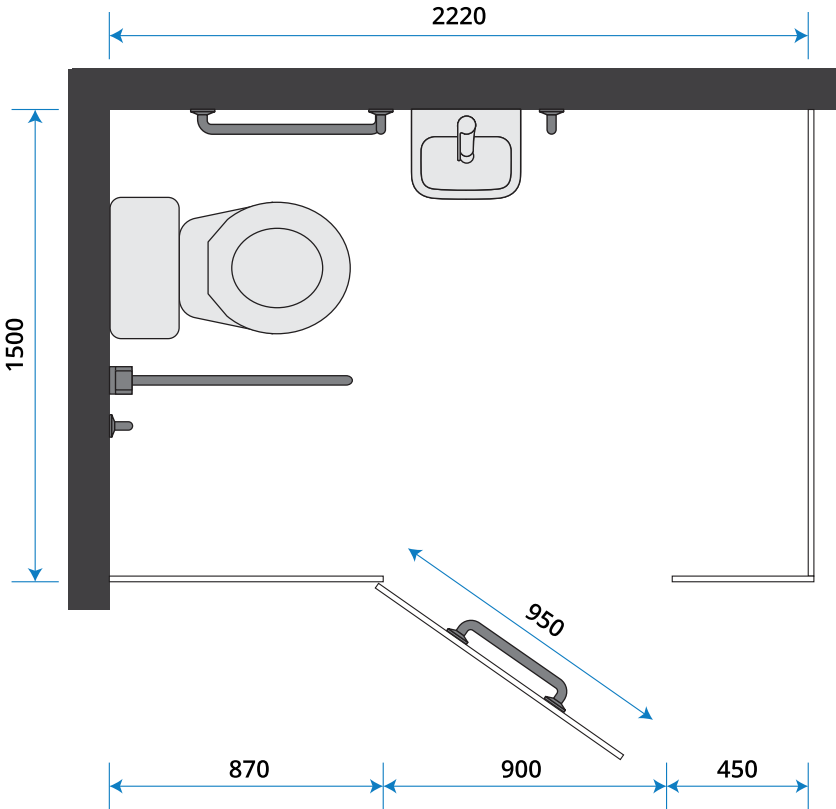

Wheelchair Accessible Cubicles:

The wheelchair accessible layout has been modified to accommodate an overall toilet cubicle length of 2220mm (previously 2000mm).

The door opening needs to be 900mm with a 950mm (wide) outward opening door.

Doc-M Packs are available to purchase online from:

plumbware.co.uk

Unisex Wheelchair Accessible Toilet Layout

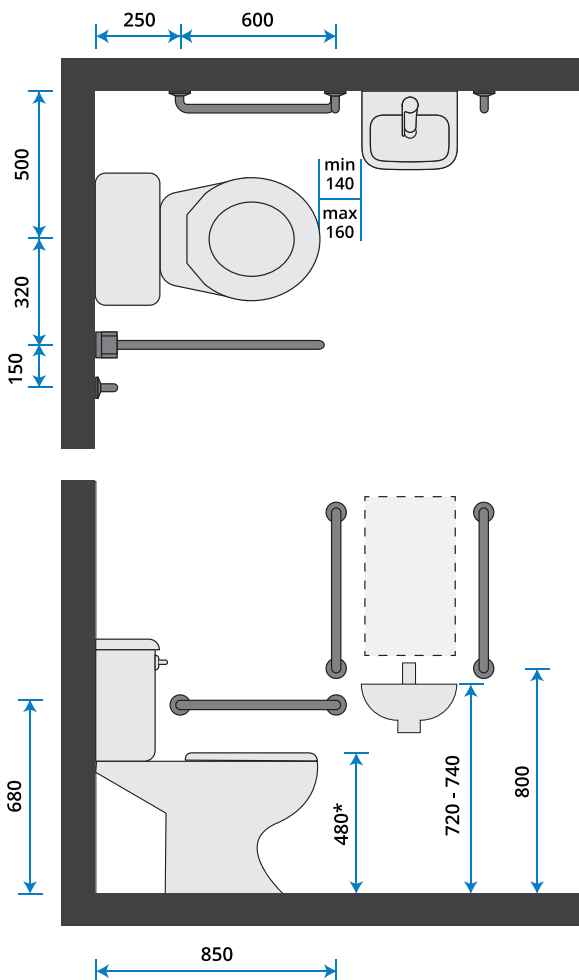

Ambulant Disabled Toilet Layout

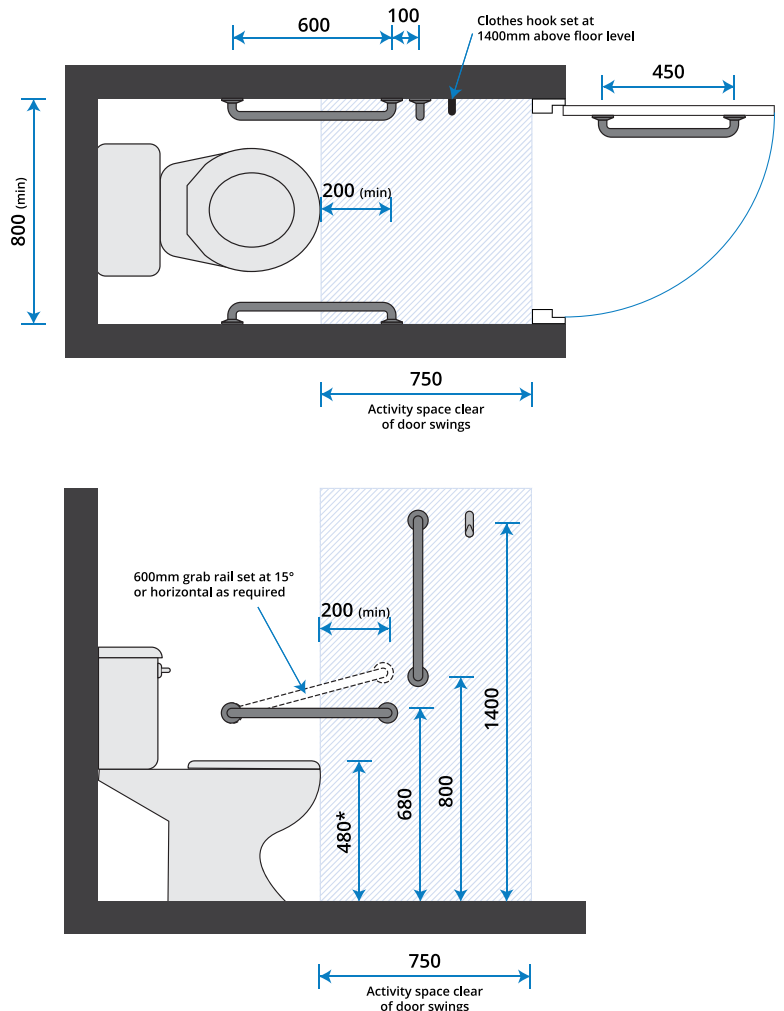

Pendle® Cubicle System



Uniclass 1.4 L2226
Uniclass 2015 Ss_25_12_60_60

NBS Create
Keynote

25-05-60/160
K32/120

Manufacturer

Cubicle Centre
+44 (0)1924 457600
design@washroomcubicles.co.uk

Available Downloads

CAD BLOCK
.dwg format

How to Order

Pendle cubicles can be ordered quickly and easily online.
To place your order visit:
www.plumbware.co.uk

Product reference Pendle Cubicle System
Material Melamine Faced Chipboard

Overall cubicle height
1950mm including a 150mm floor clearance

Partitions
Partition depth 1800mm (maximum)
Partition height 1800mm

Fittings
SAA: cubicle legs, heavy-duty hinges and cubicle latches. PVC header rail and channels.

Pendle System
Adjustments can be made to cubicles to suit site requirements by reducing doors and partitions on-site. The cut edges are protected by full-height door and wall channels.

Colours

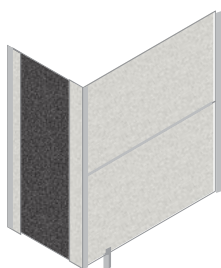

Grey

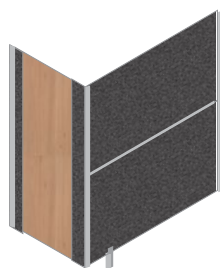

Woodgrain

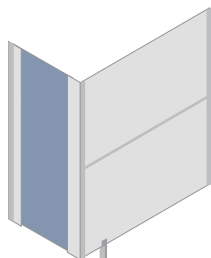

Smoke Blue

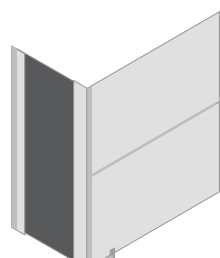

Stone Grey

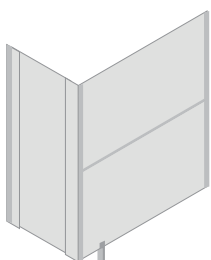

Plain Grey

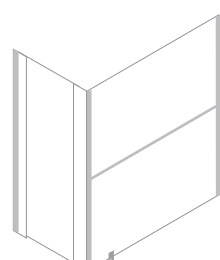

White

Pendle Dimensions
Every DOOR requires a BOX A | Every PARTITION requires a BOX B

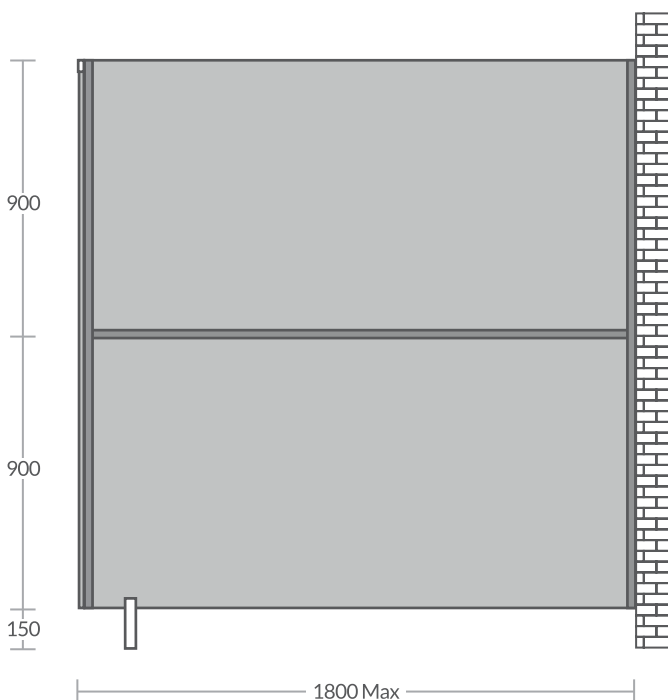
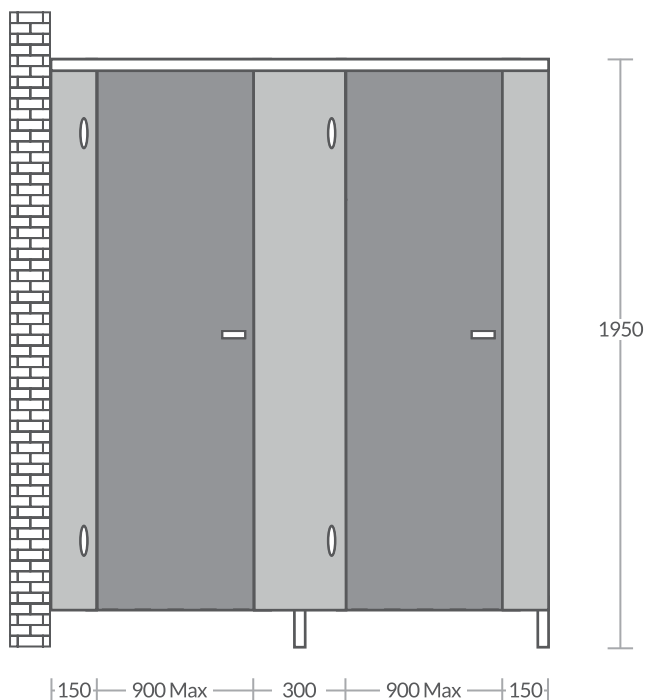

Pendle Junior[®] Cubicle System



Uniclass 1.4 L2226
Uniclass 2015 Ss_25_12_60_60

NBS Create 25-05-60/160
Keynote K32/120

Manufacturer

Cubicle Centre
+44 (0)1924 457600
design@washroomcubicles.co.uk

Available Downloads

CAD BLOCK
.dwg format

How to Order

Pendle cubicles can be ordered quickly and easily online.
To place your order visit:
www.plumbware.co.uk

Product reference Pendle Cubicle System
Material Melamine Faced Chipboard

Pendle Junior Dimensions

Every **DOOR** requires a **BOX A** | Every **PARTITION** requires a **BOX B**

Overall cubicle height

1950mm including a 150mm floor clearance

Partitions

Partition depth 1800mm (maximum)
Partition height 1800mm

Doors

Door height 1350mm (1500mm from floor)

Fittings

SAA: cubicle legs, heavy-duty hinges and cubicle latches. PVC header rail and channels.

Pendle System

Adjustments can be made to cubicles to suit site requirements by reducing doors and partitions on-site. The cut edges are protected by full-height door and wall channels.

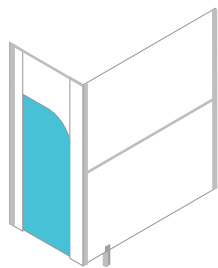
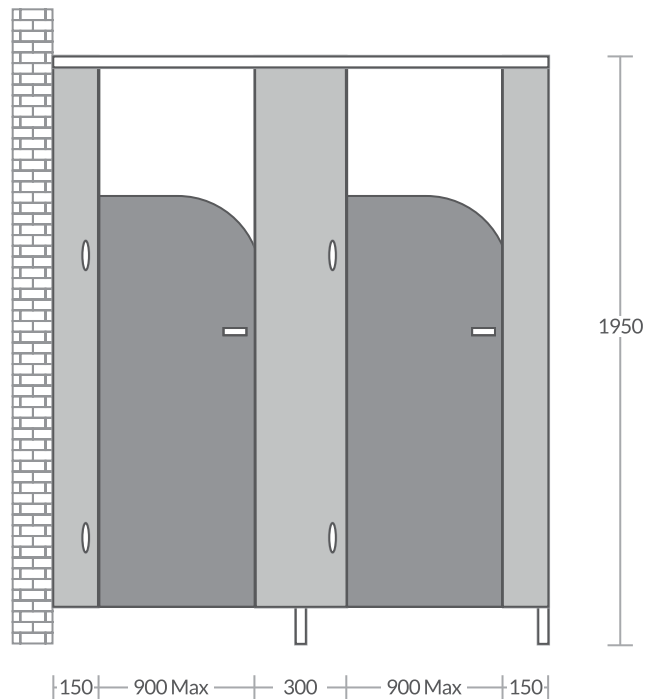

Blueberry

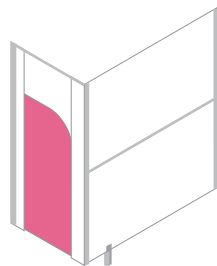

Dragon Fruit

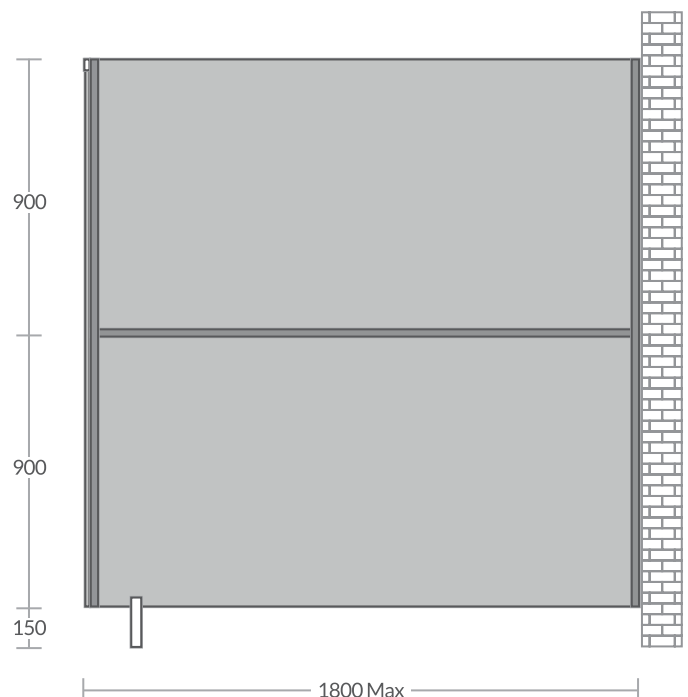

Pennine® Cubicle System

Uniclass 1.4 L2226
 Uniclass 2015 Ss_25_12_60_60

NBS Create
 Keynote

25-05-60/160
 K32/120



Manufacturer

Cubicle Centre
 +44 (0)1924 457600
design@washroomcubicles.co.uk

Available Downloads

CAD BLOCK
 .dwg format

BIM OBJECT
 .rfa format

NBS SOURCE
 Create Specification

Product reference Pennine Cubicle System
Material Melamine Faced Chipboard

Overall cubicle height
 1955mm including a 155mm floor clearance

Partitions
 Partition depth 1500mm (standard)
 Up to 1800mm
 Partition height 1800mm
 Colour Speckled Light Grey, Plain Grey, White or Cream

Doors
 Colour As Partition colour

Fittings
 SAA: head-rail, brackets, cubicle legs, heavy-duty hinges and cubicle latches

Wall Panel System
 Height Not required, Full-height, Half-height
 Material Melamine Faced Chipboard
 Panel colour Speckled Light Grey, Plain Grey, White or Cream
 Flash colour As panel colour

Standard Pennine Dimensions

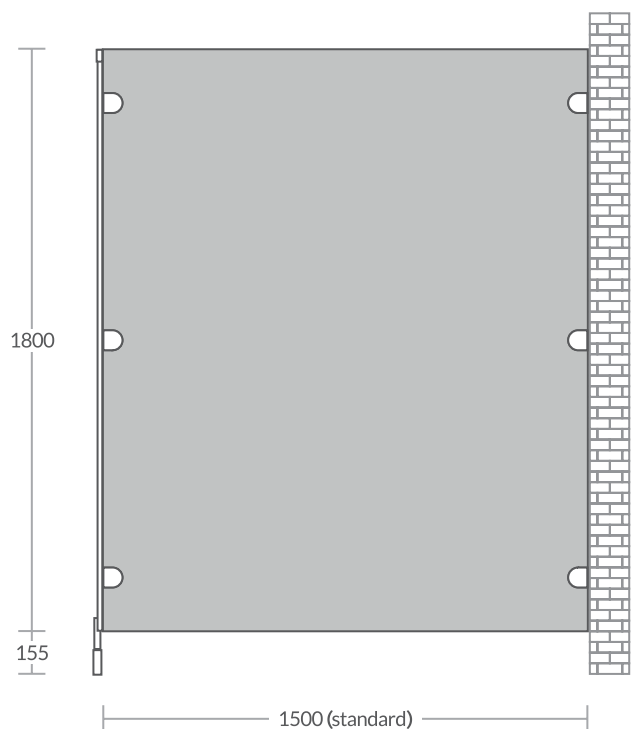
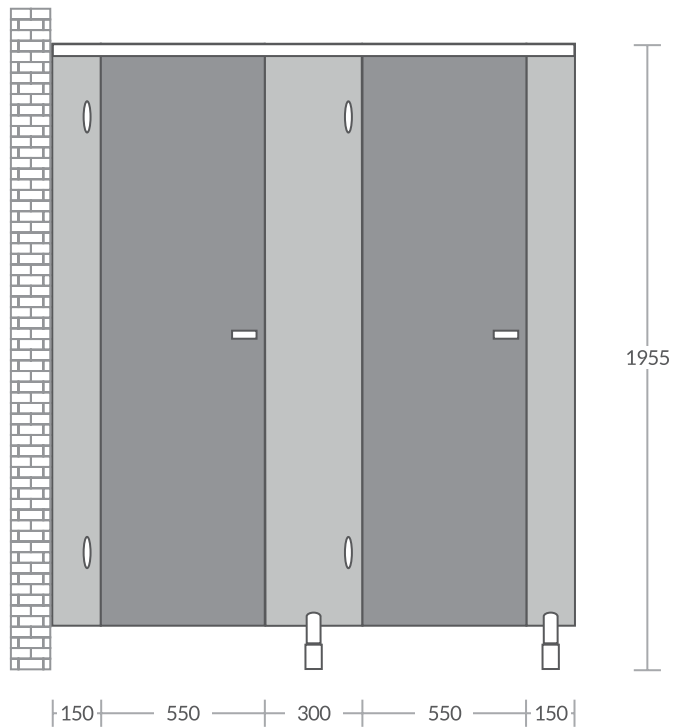

Malvern® Cubicle System



Uniclass 1.4 L2226
Uniclass 2015 Ss_25_12_60_60

NBS Create 25-05-60/160
Keynote K32/120

Manufacturer

Cubicle Centre
+44 (0)1924 457600
design@washroomcubicles.co.uk

Available Downloads

CAD BLOCK
.dwg format

BIM OBJECT
.rfa format

NBS SOURCE
Create Specification

Product reference Malvern Cubicle System
Material Melamine Faced Chipboard

Overall cubicle height
1955mm including a 155mm floor clearance

Partitions
Partition depth 1500mm (standard)
Up to 1800mm
Partition height 1800mm
Colour Speckled Light Grey, Plain Grey, White or Cream

Doors
Colour See below

Fittings
SAA: head-rail, brackets, adjustable cubicle legs, heavy-duty hinges and cubicle latches

Wall Panel System
Height Not required, Full-height, Half-height
Material Melamine Faced Chipboard
Panel colour See below
Flash colour See below

Colour
Speckled Light Grey, Speckled Anthracite, Plain Grey, White, Cream, Blue, Red, Yellow

Standard Malvern Dimensions

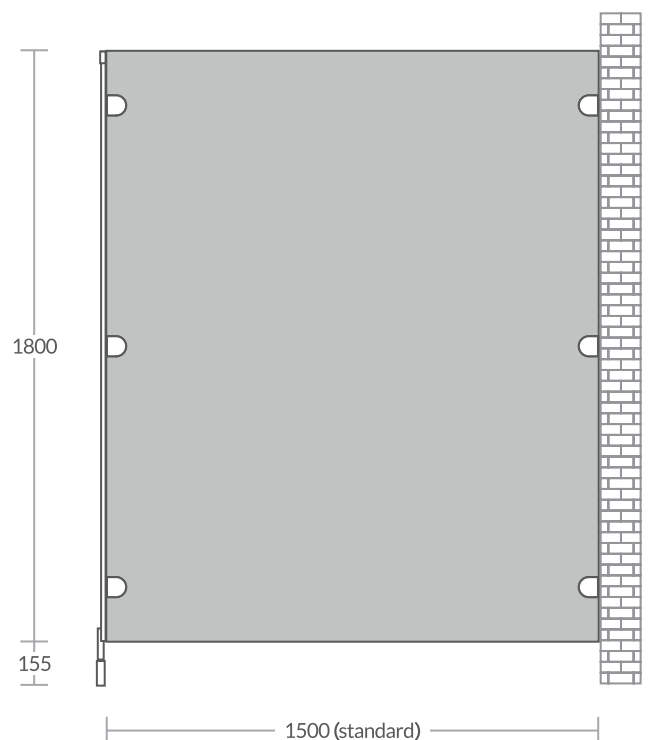
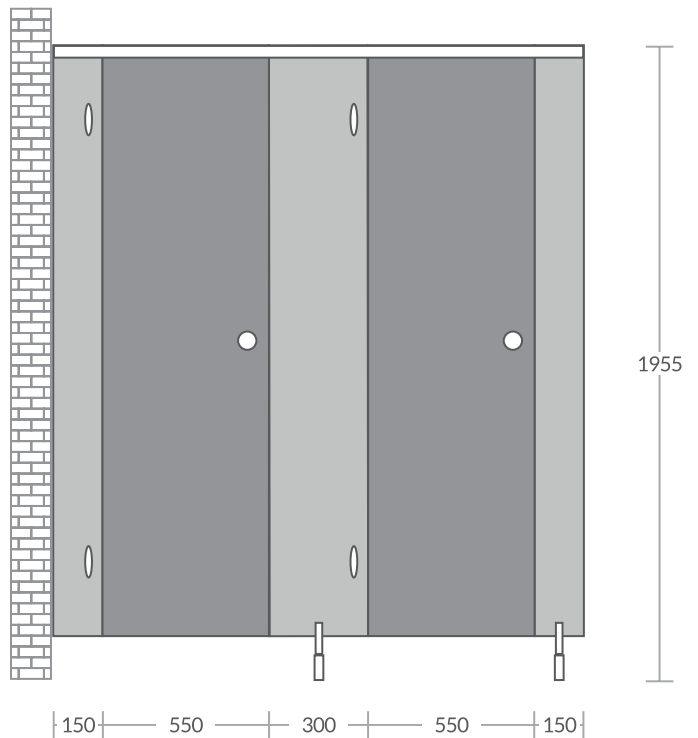

Malvern Plus[®] Cubicle System



Uniclass 1.4 L2226
Uniclass 2015 Ss_25_12_60_60

NBS Create 25-05-60/160
Keynote K32/120

Manufacturer

Cubicle Centre
+44 (0)1924 457600
design@washroomcubicles.co.uk

Available Downloads

CAD BLOCK
.dwg format

BIM OBJECT
.rfa format

NBS SOURCE
Create Specification

Product reference Malvern Plus Cubicle System
Material Melamine Faced Chipboard

Overall cubicle height
1955mm including a 155mm floor clearance

Partitions
Partition depth 1500mm (standard)
Up to 1800mm
Partition height 1800mm
Colour See below

Doors
Colour See below

Fittings
SAA: head-rail, brackets, adjustable cubicle legs, heavy-duty hinges and cubicle latches

Wall Panel System
Height Not required, Full-height, Half-height
Material Melamine Faced Chipboard
Panel colour See below
Flash colour See below

Colour
Full colour range
www.washroomcubicles.co.uk/malvern-plus-colours/

Increased Height
[Available in an increased height configuration \(See page 53\)](#)

Standard Malvern Plus Dimensions

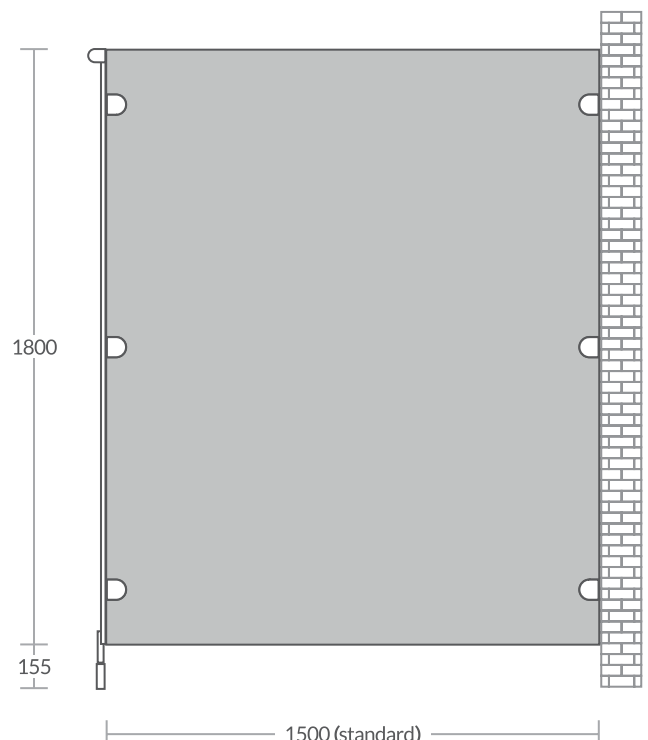
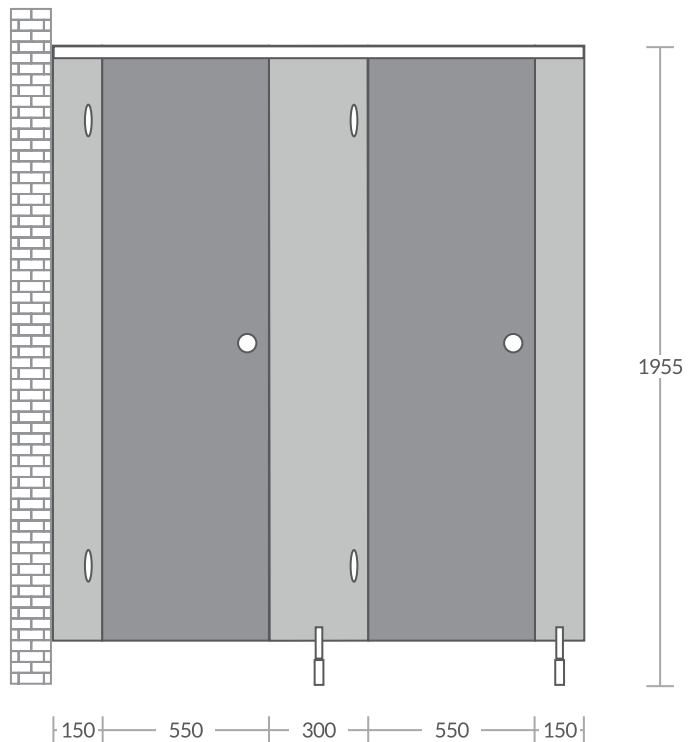

Grampian® Cubicle System

Uniclass 1.4 L2226
Uniclass 2015 Ss_25_12_60_60

NBS Create 25-05-60/160
Keynote K32/120



Manufacturer

Cubicle Centre
+44 (0)1924 457600
design@washroomcubicles.co.uk

Available Downloads

CAD BLOCK
.dwg format

BIM OBJECT
.rfa format

NBS SOURCE
Create Specification

Product reference Grampian Cubicle System
Material High Pressure Laminate

Overall cubicle height
1955mm including a 155mm floor clearance

Partitions
Partition depth 1500mm (standard)
Up to 1500mm
Partition height 1800mm
Colour See below

Doors
Colour See below

Fittings
SAA: head-rail, brackets, adjustable cubicle legs, heavy-duty hinges and cubicle latches

Wall Panel System
Height Not required, Full-height, Half-height
Material High Pressure Laminate
Panel colour See below
Flash colour See below

Colour
Full colour range
www.washroomcubicles.co.uk/high-pressure-laminate/

Increased Height
[Available in an increased height configuration \(See page 53\)](#)

Standard Grampian Dimensions

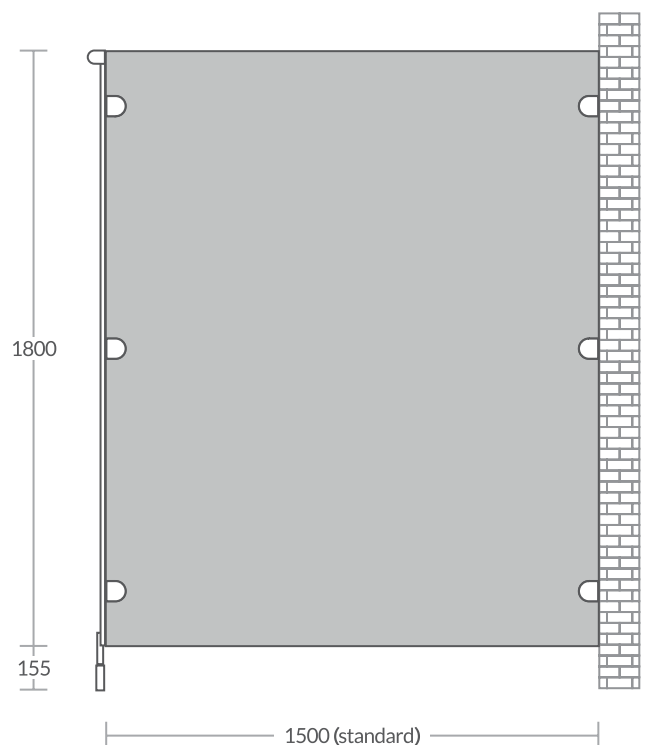
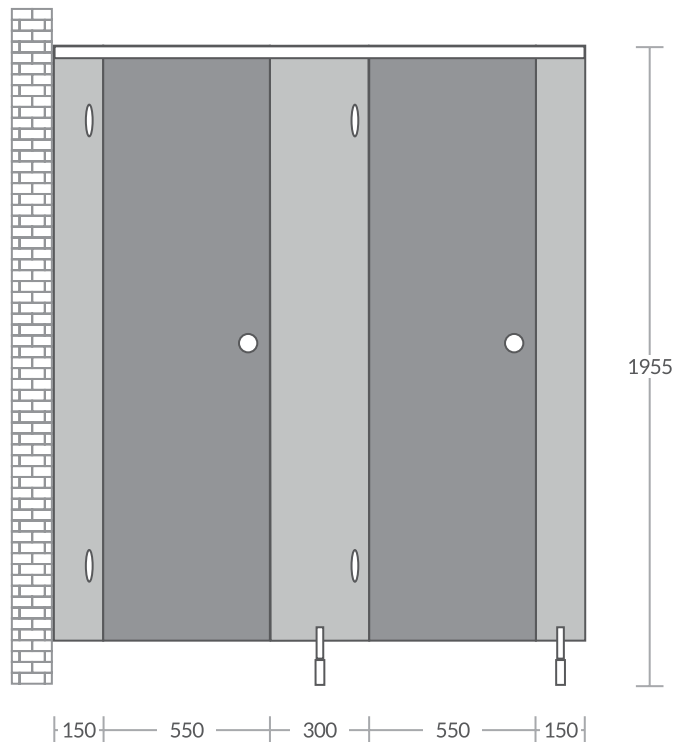

Cairngorm® Cubicle System



Uniclass 1.4 L2226 NBS Create 25-05-60/160
 Uniclass 2015 Ss_25_12_60_60 Keynote K32/120

Manufacturer

Cubicle Centre
 +44 (0)1924 457600
design@washroomcubicles.co.uk

Available Downloads

CAD BLOCK
 .dwg format

BIM OBJECT
 .rfa format

NBS SOURCE
 Create Specification

Product reference Cairngorm Cubicle System
Material Compact Grade Laminate

Overall cubicle height
 1955mm including a 155mm floor clearance

Partitions

Partition depth 1500mm (standard)
 Up to 1800mm
 Partition height 1800mm
 Colour See below

Doors

Colour See below

Fittings

SAA: head-rail, brackets, wide-base cubicle legs, heavy-duty hinges and cubicle latches

Wall Panel System

Height Not required, Full-height, Half-height
 Material Compact Grade Laminate
 Panel colour See below
 Flash colour See below

Colour

Full colour range
www.washroomcubicles.co.uk/compact-grade-laminate/

Increased Height

[Available in an increased height configuration \(See page 53\)](#)

Standard Cairngorm Dimensions

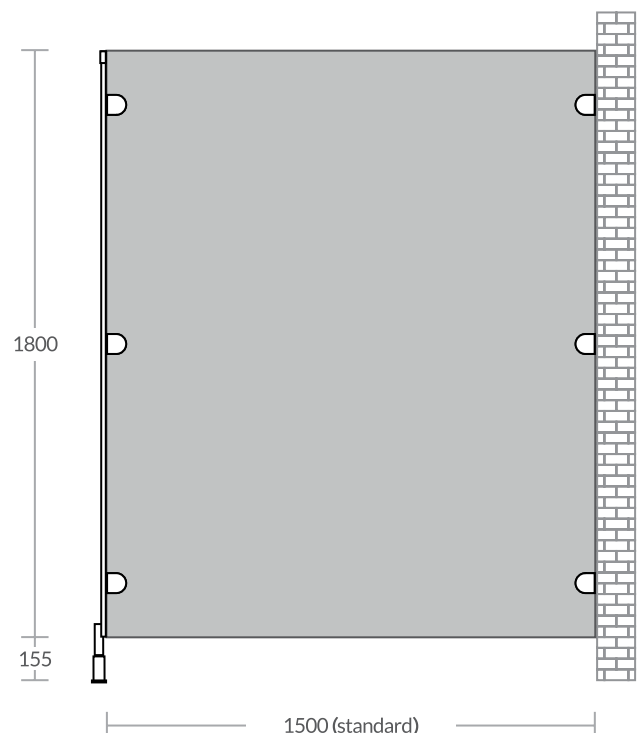
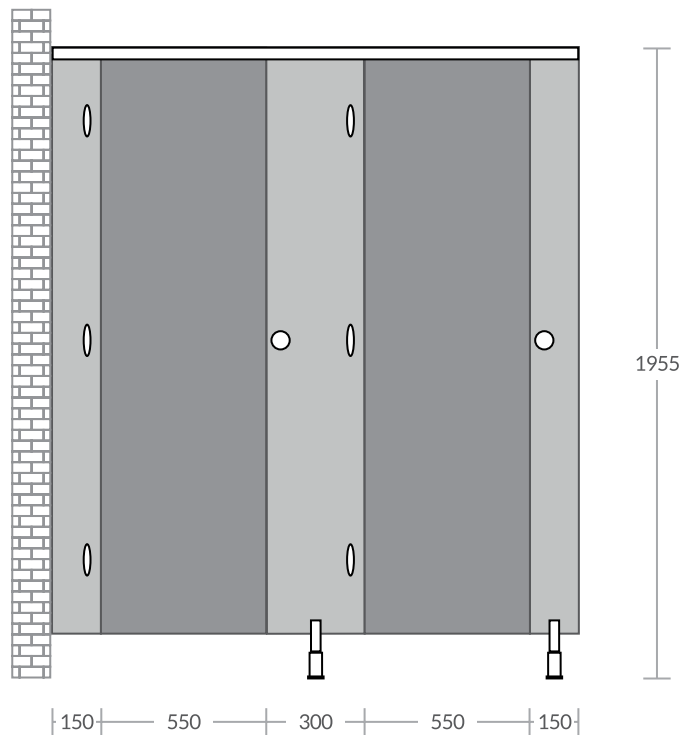

Increased Height WC Cubicles



Uniclass 1.4 L2226 NBS Create 25-05-60/160
Uniclass 2015 Ss_25_12_60_60 Keynote K32/120

Manufacturer

Cubicle Centre
+44 (0)1924 457600

design@washroomcubicles.co.uk

Product reference and Material

Increased Height WC Cubicles:
Malvern Plus - Melamine Faced Chipboard
Grampian - High Pressure Laminate
Cairngorm - Compact Grade Laminate

Overall cubicle height

2100mm including a 100mm floor clearance

Partitions

Partition depth 1500mm (standard)
Up to 1800mm
Partition height 2000mm
Colour See below

Doors

Colour See below

Fittings

SAA: head-rail, brackets, partition pedestals, heavy-duty hinges and cubicle latches

Wall Panel System

Height Not required, Full-height, Half-height
Material Melamine Faced Chipboard
High Pressure Laminate
Compact Grade Laminate
Compact Density Fibreboard
Panel colour See below
Flash colour See below

Colour

Full colour range

www.washroomcubicles.co.uk/increased-height-cubicles/

Increased Height WC Dimensions

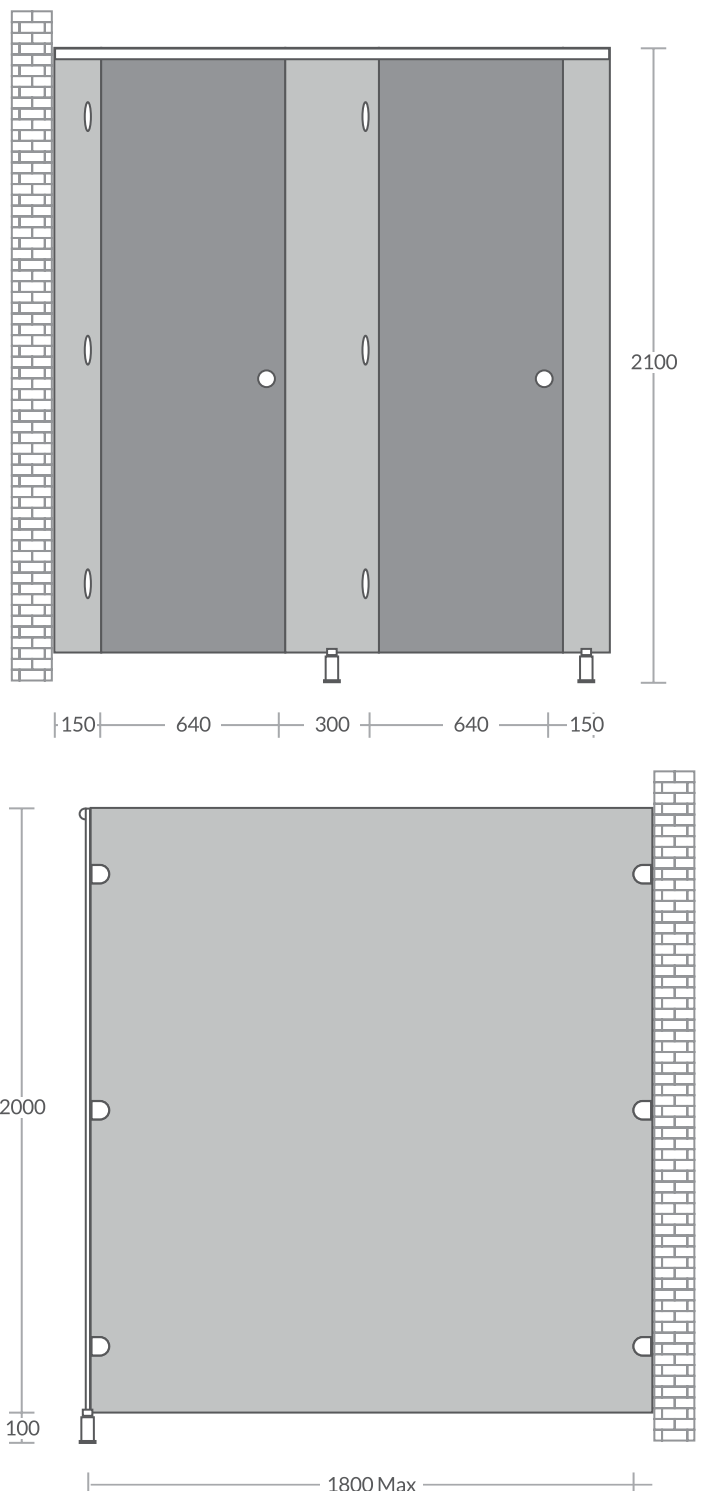

Privacy™ Cubicle System



Uniclass 1.4 L2226 NBS Create 25-05-60/130
Uniclass 2015 Ss_25_12_60_30 Keynote K32/112

Manufacturer

Cubicle Centre
+44 (0)1924 457600
design@washroomcubicles.co.uk

Available Downloads

CAD BLOCK .dwg format	BIM OBJECT .rfa format	NBS SOURCE Create Specification
---------------------------------	----------------------------------	---

Product reference Privacy Cubicle System
Material Compact Grade Laminate

Overall cubicle height
2600mm (max) including a 15mm floor clearance at door

Partitions
Partition depth 1500mm (standard)
Up to 2000mm
Partition height Up to 2600mm
Colour See below

Doors
Colour See below

Fittings
SAA: head-rail, wall and partition channels, heavy-duty hinges and cubicle latches

Wall Panel System
Height Not required, Full-height, Half-height
Material Compact Grade Laminate
Panel colour See below
Flash colour See below

Colour
Full colour range
www.washroomcubicles.co.uk/privacy-cubicle-colours/

Standard Privacy Dimensions

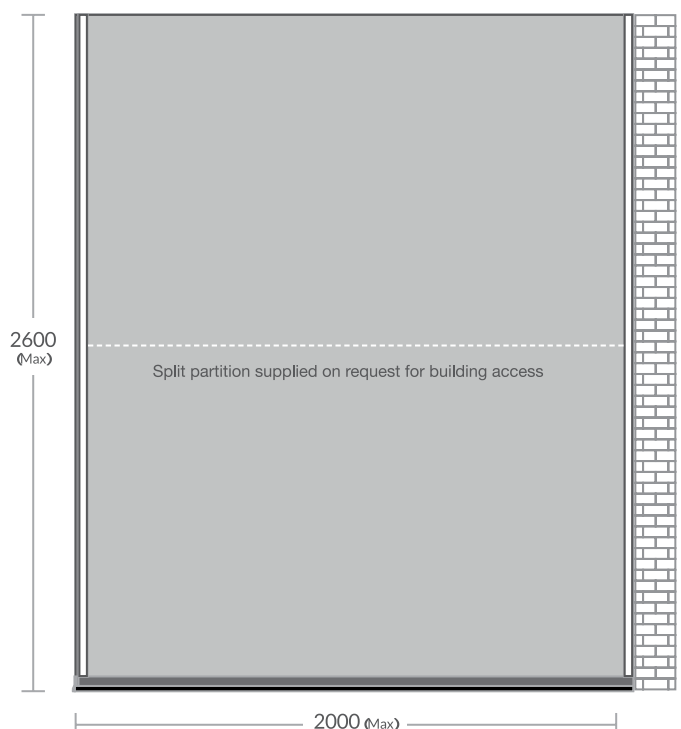
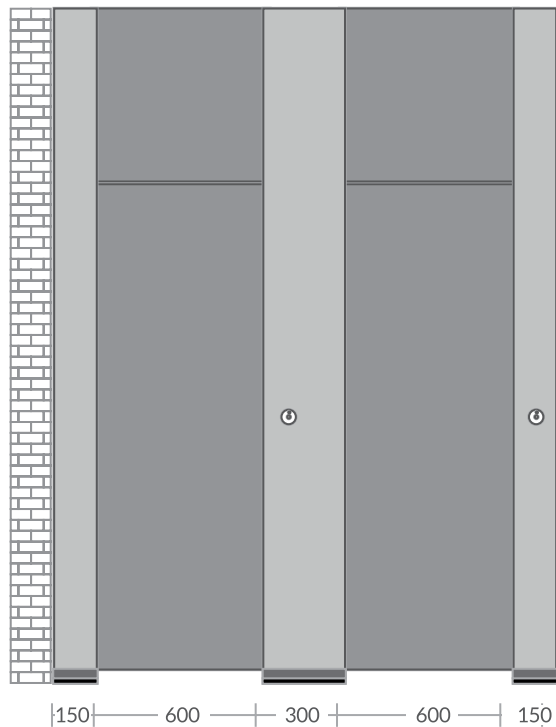

Cotswold[®] Cubicle System



Uniclass 1.4 L2226 NBS Create 25-05-60/130
Uniclass 2015 Ss_25_12_60_30 Keynote K32/112

Manufacturer

Cubicle Centre
+44 (0)1924 457600
design@washroomcubicles.co.uk

Available Downloads

CAD BLOCK .dwg format	BIM OBJECT .rfa format	NBS SOURCE Create Specification
---------------------------------	----------------------------------	---

Product reference Cotswold Cubicle System
Material Compact Grade Laminate (standard)
Melamine Faced Chipboard

Overall cubicle height
1980mm including a 150mm floor clearance

Partitions
Partition depth 1500mm (standard)
Up to 1800mm
Partition height 1800mm
Colour See below

Doors
Colour See below

Fittings
Pilasters at 112mm (end) and 200mm (middle) as site ready sub-assemblies; hinges, leg supports, latches and wall channels (powder-coated finish)

Wall Panel System
Height Not required, Full-height, Half-height
Material Compact Grade Laminate (standard)
Melamine Faced Chipboard
Panel colour See below
Flash colour See below

Colour
Full colour range
www.washroomcubicles.co.uk/compact-grade-laminate/
www.washroomcubicles.co.uk/melamine-faced-chipboard/

Standard Cotswold Dimensions

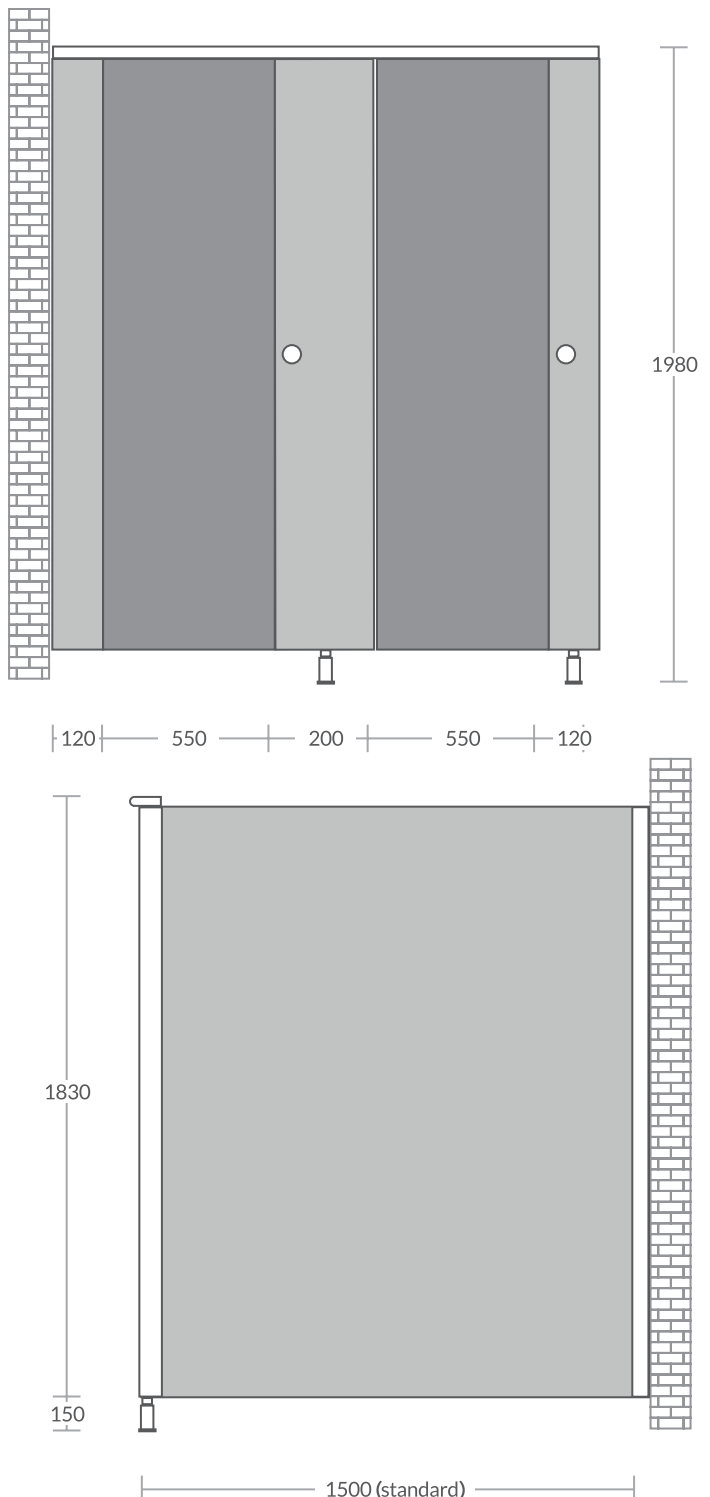

Brecon[®] Cubicle System



Uniclass 1.4 L2226
Uniclass 2015 Ss_25_12_60_60

NBS Create 25-05-60/160
Keynote K32/120

Manufacturer

Cubicle Centre
+44 (0)1924 457600
design@washroomcubicles.co.uk

Available Downloads

CAD BLOCK
.dwg format

BIM OBJECT
.rfa format

NBS SOURCE
Create Specification

Product reference Brecon Cubicle System
Material Melamine Faced Chipboard
Compact Grade Laminate
High Pressure Laminate

Overall cubicle height
1955mm including a 155mm floor clearance

Partitions

Partition depth 1500mm (standard)
Up to 1800mm
Partition height 1800mm (standard)
1200mm, 1350mm, 1500mm shaped
partition at extra cost
Colour See below

Doors

Door profile Arch,
Square or
Reverse Curve
w/ 300mm drop



Door height 1200mm (Arch or Square only),
1350mm, 1500mm

Colour See below
Decorative vinyl Happy Everything, Space Adventure,
Colourful Chameleons, Ocean View

Fittings

SAA or Powder-coated (multi-coloured): head-rail, brackets,
adjustable cubicle legs, heavy-duty hinges and cubicle latches

Wall Panel System

Height Not required, Full-height, Half-height
Material Melamine Faced Chipboard
Panel colour See below
Flash colour See below

Colour

Blue, Red, Yellow, Green, White, Cream, Plain Grey, Stone Grey,
Blueberry, Kiwifruit, Mango, Dragon Fruit

Notes

[Brecon is available in CGL @ extra cost](#)

Standard Brecon Dimensions

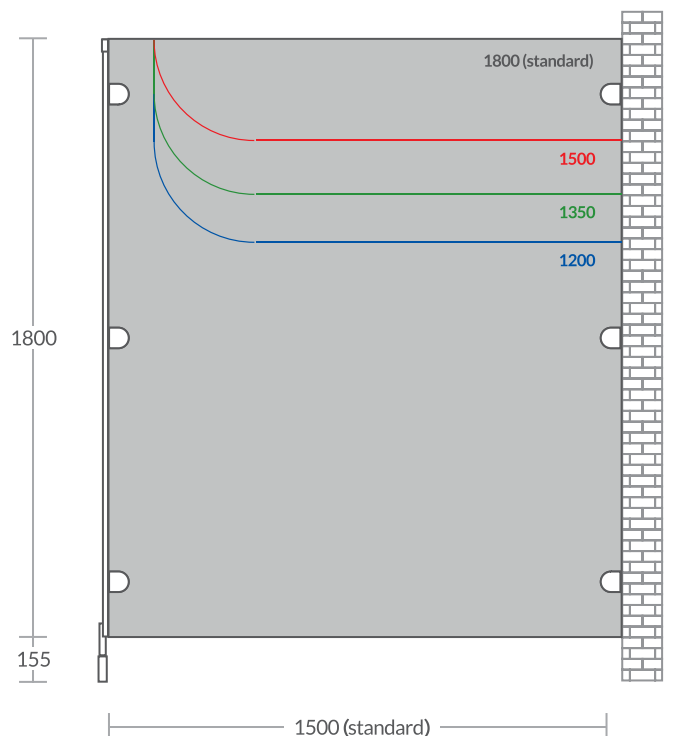
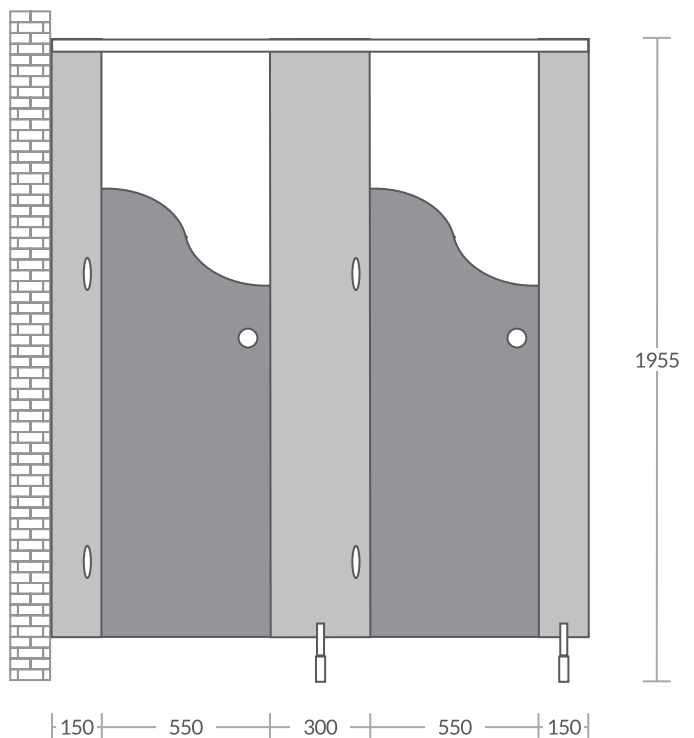

Sydney[®] Cubicle System



Uniclass 1.4 L2226
Uniclass 2015 Ss_25_12_60_60

NBS Create 25-05-60/160
Keynote K32/120

Manufacturer

Cubicle Centre
+44 (0)1924 457600

design@washroomcubicles.co.uk

Available Downloads

CAD BLOCK
.dwg format

BIM OBJECT
.rfa format

NBS SOURCE
Create Specification

Product reference Sydney Cubicle System
Material Melamine Faced Chipboard
Compact Grade Laminate
High Pressure Laminate

Overall cubicle height
1500mm including a 100mm floor clearance

Partitions
Partition depth 1500mm (standard)
Up to 1800mm
Partition height 1100mm
Colour See below

Doors
Door height 1100mm
Colour See below
Decorative vinyl Happy Everything, Space Adventure
Colourful Chameleons, Ocean View

Fittings
SAA: brackets, floor supports, heavy-duty hinges, door handles and magnetic catches

Wall Panel System
Height Not required, Full-height, Half-height
Material Melamine Faced Chipboard
Panel colour See below
Flash colour See below

Colour
Blue, Red, Yellow, Green, White, Cream, Plain Grey, Stone Grey,
Blueberry, Kiwifruit, Mango, Dragon Fruit

Notes
[Sydney is available in CGL @ extra cost](#)

Standard Sydney Dimensions

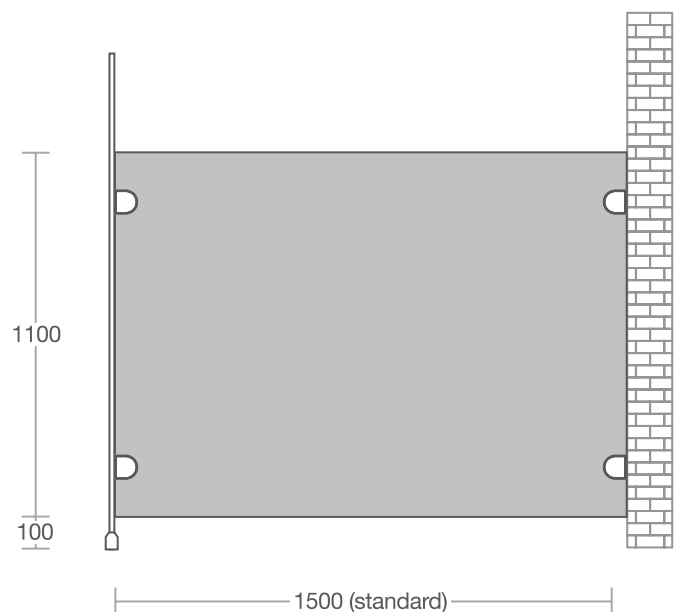
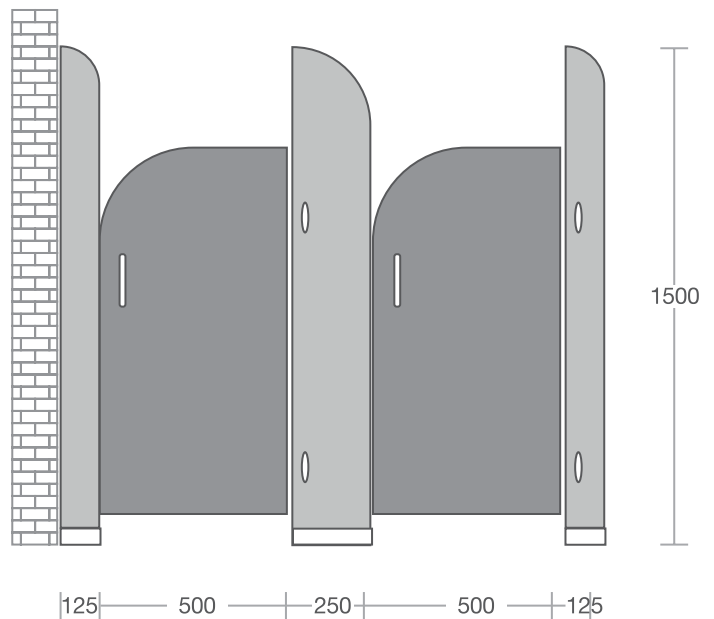

Vanity Units



Uniclass 1.4 L7212
Uniclass 2015 Pr_40_20_76_94

NBS Create 45-35-72/378
Keynote N10/145

Manufacturer

Cubicle Centre
+44 (0)1924 457600
design@washroomcubicles.co.uk

Available Downloads

CAD BLOCK .dwg format	BIM OBJECT .rfa format	NBS SOURCE Create Specification
---------------------------------	----------------------------------	---

Product reference Vanity Unit
Material High Pressure Laminate (standard)
Compact Grade Laminate

Overall vanity height 850mm (standard)
or to suit individual requirements

Vanity type
Type Inset (550mm deep)
Semi-Recessed (350mm deep)

Vanity top
Material High Pressure Laminate (standard)
Compact Grade Laminate
Colour See below

Vanity panels
Material Melamine Faced Chipboard (standard)
High Pressure Laminate
Compact Grade Laminate
Colour See below

Light pelmet
Material High Pressure Laminate (standard)
Colour See below

Colour
HPL (standard)
www.washroomcubicles.co.uk/high-pressure-laminate/
MFC
www.washroomcubicles.co.uk/melamine-faced-chipboard/
CGL
www.washroomcubicles.co.uk/compact-grade-laminate/

Inset Vanity Unit

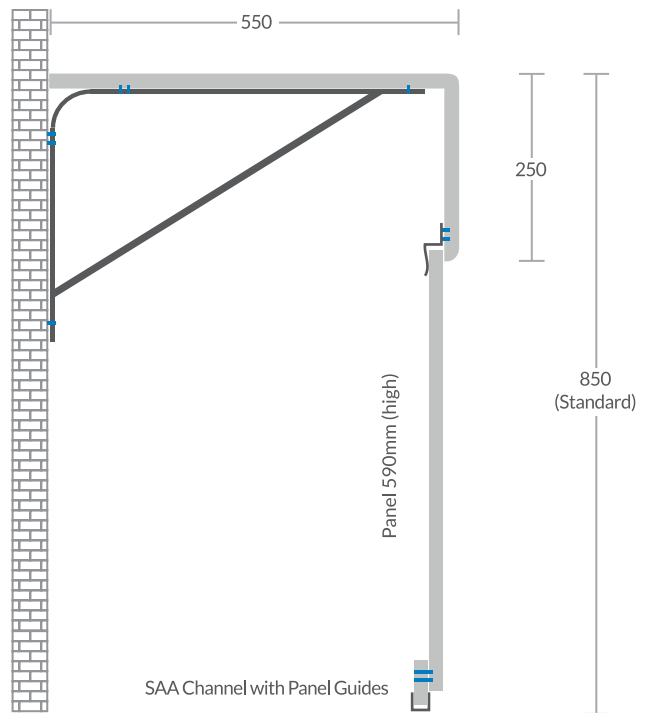

Semi-Recessed Vanity Unit

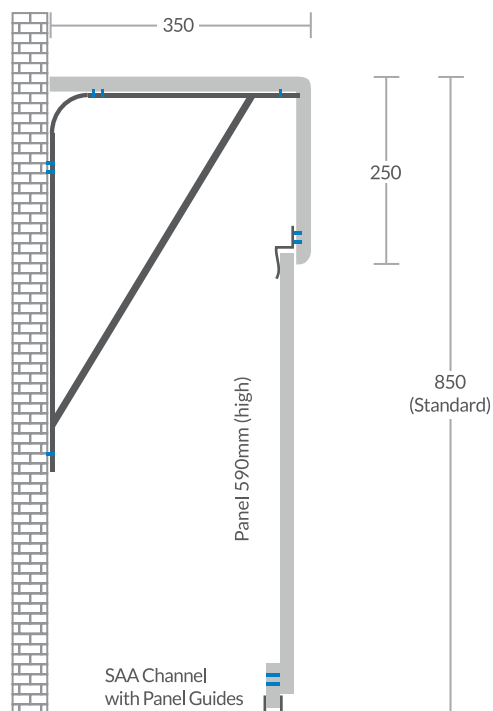

Corian® Vanity Units



Uniclass 1.4 L7212 NBS Create 45-35-72/378
Uniclass 2015 Pr_40_20_76_94 Keynote N10/145

Manufacturer

Other

+44 (0)1924 457600

design@washroomcubicles.co.uk

Product reference Corian Vanity Unit
Material Corian® by Dupont™
Composed 1/3 acrylic resin
and 2/3 natural minerals

Overall vanity height 850mm (standard)
or to suit individual requirements

Vanity or trough type
Type Inset (550mm deep)
Semi-Recessed (350mm deep)
Surface mounted (550mm deep)
Under mounted (550mm deep)
Trough (550mm deep)

Colour See below

Vanity panels
Material Melamine Faced Chipboard
High Pressure Laminate
Compact Grade Laminate
Colour See below

Framing
Timber frame supplied by other

Colour (basin and trough surface)
Corian
www.washroomcubicles.co.uk/corian-finish-options/

Colour (underpanels)
HPL (standard)
www.washroomcubicles.co.uk/high-pressure-laminate/
MFC
www.washroomcubicles.co.uk/melamine-faced-chipboard/
CGL
www.washroomcubicles.co.uk/compact-grade-laminate/

Typical installation

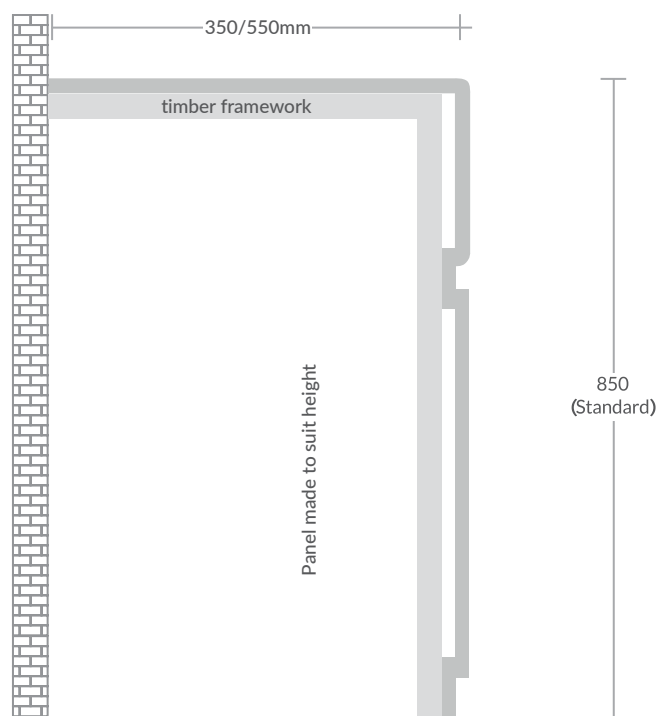

Wall Panel Systems



Uniclass 1.4 L516
Uniclass 2015 Ss_25_25_45_25

NBS Create 25-85-45/120
Keynote K32/140

Manufacturer

Cubicle Centre
+44 (0)1924 457600

design@washroomcubicles.co.uk

Available Downloads

CAD BLOCK .dwg format	BIM OBJECT .rfa format	NBS SOURCE Create Specification
---------------------------------	----------------------------------	---

Product reference

Wall Panel System

Material

Melamine Faced Chipboard (standard)
High Pressure Laminate
Compact Grade Laminate

Overall panel system height

Up to 2800mm - can be manufactured to suit individual requirements

Panels

Height Up to 2800mm
Full-height
Half-height (1200mm standard)

Material Melamine Faced Chipboard (standard)
High Pressure Laminate
Compact Grade Laminate

Panel colour See below

Panel edging 2.0mm PVC lipping (MFC or HPL)
Post-formed verticle edges (HPL)
Black, machine rounded profile (CGL)

Flash colour See below

Framing

Timber frame supplied by other

Colour

MFC (standard)
www.washroomcubicles.co.uk/melamine-faced-chipboard/
HPL
www.washroomcubicles.co.uk/high-pressure-laminate/
CGL
www.washroomcubicles.co.uk/compact-grade-laminate/

Wall Panel Configurations

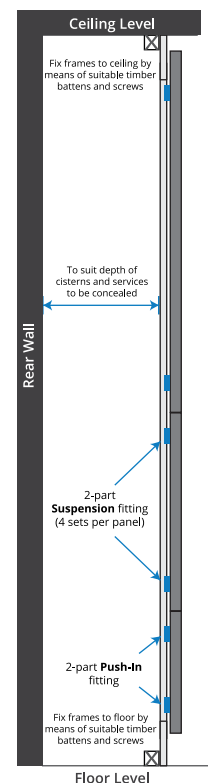
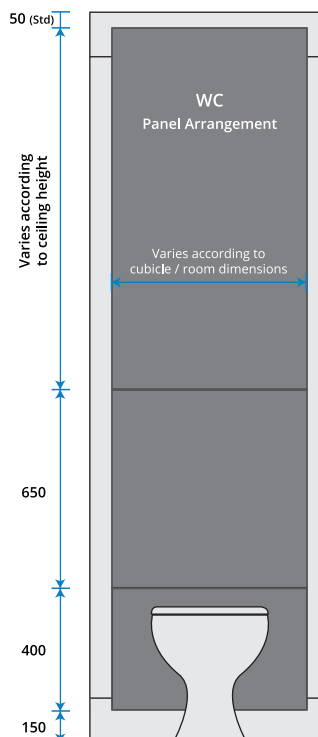
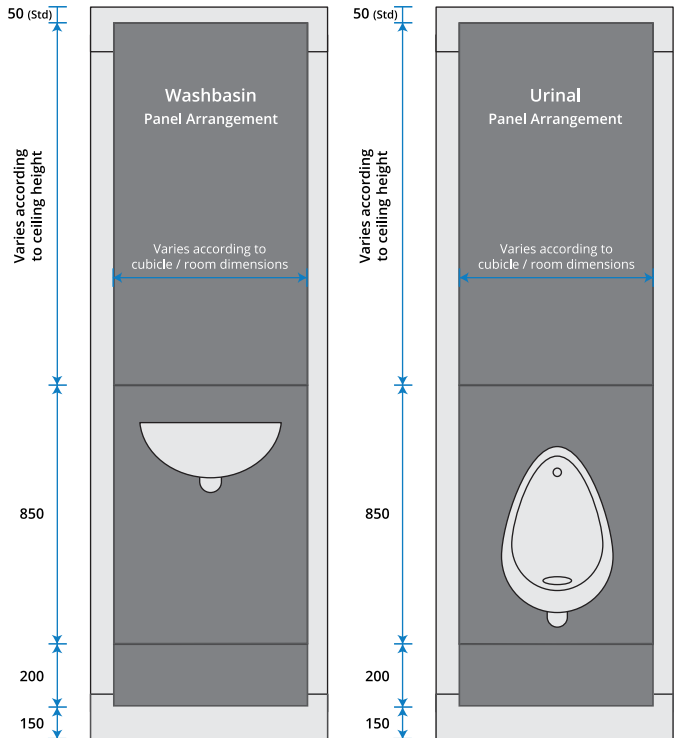

Timber frame supplied by other

Pendle Panel Systems



Uniclass 1.4 L516
Uniclass 2015 Ss_25_25_45_25

NBS Create 25-85-45/120
Keynote K32/140

Manufacturer

Cubicle Centre
+44 (0)1924 457600
design@washroomcubicles.co.uk

Available Downloads

CAD BLOCK
.dwg format

How to Order

Pendle cubicles can be ordered quickly and easily online.
To place your order visit:
www.plumbware.co.uk

Product reference Wall Panel System
Material Melamine Faced Chipboard

Overall panel system height
1950mm to match Pendle/Pendle Junior cubicle system

Panels
Height 1950mm
Material Melamine Faced Chipboard
Panel edging 2.0mm PVC lipping (MFC)

Framing Timber frame supplied by other

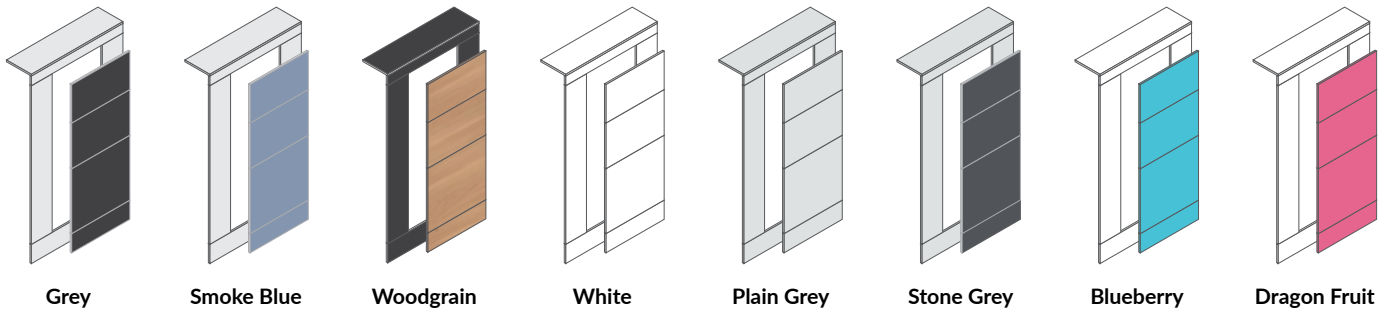

WC Panel System

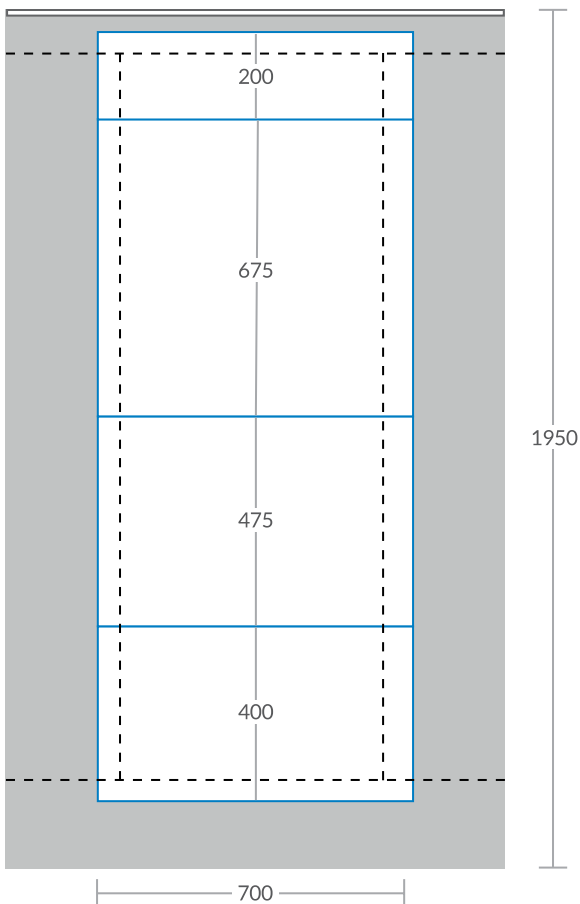

Urinal Panel System

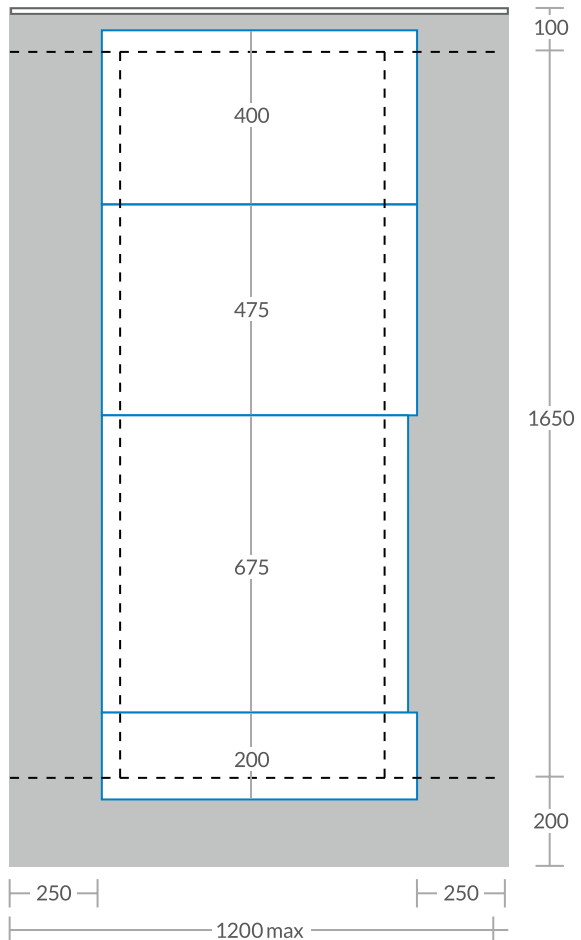

Frequently Asked Questions

Do you offer a fit-out service?

Cubicle Centre manufacture and supply only.

Our washroom systems are designed to be easily assembled by competent tradespersons.

Can I buy replacement / spare parts?

Maintenance Packs (including spare fittings) can be supplied with your initial order on request, at extra cost.

Replacement parts will only be sold for Cubicle Centre washroom systems.

What is the recommended minimum size for a standard toilet cubicle?

750mm (wide) x 1500mm (deep)

See page 44 for Universal Access Guidelines.

What is the 'cubicle configuration'?

We need to know which of the following five situations your cubicles will be fitted in:

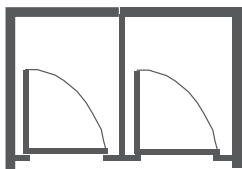

Enclosed
(between walls)

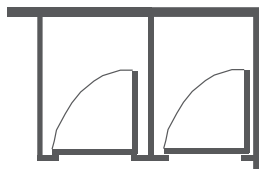

Corner

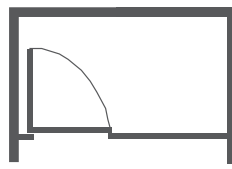

In-line

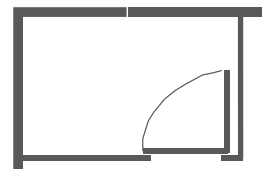

In-line with return

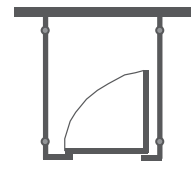

Standalone

What is your budget range of toilet cubicles?

Pennine (page 09) offers a practical washroom solution for those with a low budget.

See page 04 for Cubicle Product Guide.

I need some cubicles urgently...

The *Pendle* and *Pendle Junior* cubicle systems are usually dispatched within 48 hours of order. See page 06 and 07 for further details.

The complete *Pendle* range can be ordered online at Plumbware.co.uk



How do I get a quote?

Due to the majority of products being made to measure, pricing is on a job-to-job basis.

Email (sales@washroomcubicles.co.uk) your washroom requirements to us along with a drawing or sketch and we'll do the rest.

Alternatively, visit www.washroomcubicles.co.uk/quote to fill in an online form. Our sales team are on hand to answer any questions you may have on 01924 457600.

Frequently Asked Questions

How quickly can I have my order?

Lead times can vary from 5 to 15 working days depending on your specific requirements.

PLEASE NOTE: Lead times may increase during busier periods of the year (i.e. school holidays)

Those looking to refurbish washrooms during school holidays are advised to place their order several weeks beforehand.

Which product is best suited for use in shower / changing areas?

The *Cairngorm*, *Cotswold* and *Privacy* cubicle systems are suited for use in shower / changing areas or in areas that are likely to be subject to a wet environment or vandalism.

What are the different types of panel material?

Our products have various types of panel materials suited to different environments. *Melamine Faced Chipboard (MFC)* is suited to standard washrooms, while *Compact Grade Laminate (CGL)* is waterproof and durable and perfect for heavy use washrooms. A full description of each material can be found on page 05 Material Guide.

Do you offer screen printed doors for children's cubicles?

Cubicle Centre offer an alternative range of exclusive vinyl designs which can be applied to your cubicle doors on request. See below for some of the designs available.



Happy Everything



Space Adventure

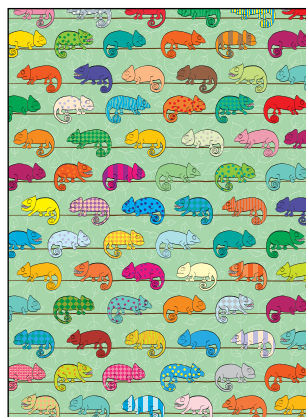

Colourful Chameleons



Ocean View

What should I clean the cubicles with?

For MFC products, remove general stains and marks with a proprietary non-abrasive bathroom or kitchen surface cleaning solution on a damp cloth. Do not use excessive amounts of water or solution.

CGL products are water proof and can therefore be cleaned more intensely with water and solution.

Avoid scrubbing or using anything with sharp edges in contact with the panels.

Can I open an account?

You may apply to open an account with us.

Account application forms are available from our website:

<https://www.washroomcubicles.co.uk/wp-content/uploads/2019/07/Credit-Application.pdf>

Unless you currently hold an account with us, all made to measure bespoke items are subject to pro-forma prepayment.

We accept: BACS / CHAPS or



Frequently Asked Questions

How do I install my cubicles?

Cubicle Centre manufacture and supply only and recommend that fitting is done by a competent joinery team. Each range has it's own set of fitting instructions sent with the order. Our team can help with any other instructions via telephone.

How do I calculate the number of toilets and wash basins I should provide?

The British Standard 6465-1:2006 Sanitary Installations document has information, formulas and tables explaining how many toilets, urinals and basins should be provided. The calculations are different for each location. The document covers, schools, offices, shopping centres, entertainment venues, restaurants, pubs and swimming pools. A full break down can be found at:

www.washroomcubicles.co.uk/how-many-toilets-do-you-need/

Are there any regulations I need to consider when planning a washroom?

Different sectors have different washroom regulations. For example a school has different toilet layout regulations to an office. To save time and effort when planning your project we created PDF guides for different sectors. Schools, offices, leisure centres, stadiums and holiday parks are all covered.

To download your guide visit:

www.washroomcubicles.co.uk/washroom-guides/

Do you offer any help to architects or specifiers?

We have created a range of resources to help with the planning of a washroom project. 2D CAD drawings 3D BIM files, specification sheets and a customised specification tool are all available at:

www.washroomcubicles.co.uk/architects/

Do you offer any posters for children?

We created a range of fun illustrated posters that remind children to wash their hands, put rubbish in the bin and drink water. These can be downloaded for **free** from:

www.washroomcubicles.co.uk/posters/

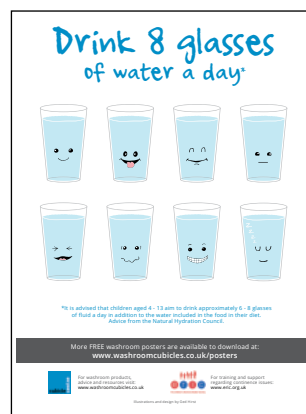
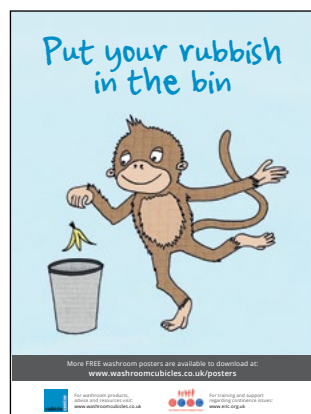
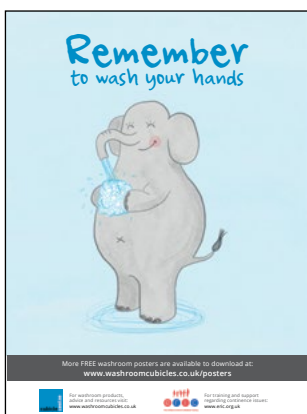

Disclaimer

© 2022 Cubicle Centre

Whilst every care has been taken to ensure the information included in this brochure was correct at the time of printing, we reserve the right to change specifications at any time without prior notice. Where specification is critical, please contact us to ensure you have the latest available information. The colours in this brochure are within the constraints of the printing process and are NOT to be used for matching purposes.

Disability Discrimination Act - Building Regulations:

The responsibility for washroom compliance with current building regulations lies with the project manager. However, on request, we can offer advice on this subject.

Notes

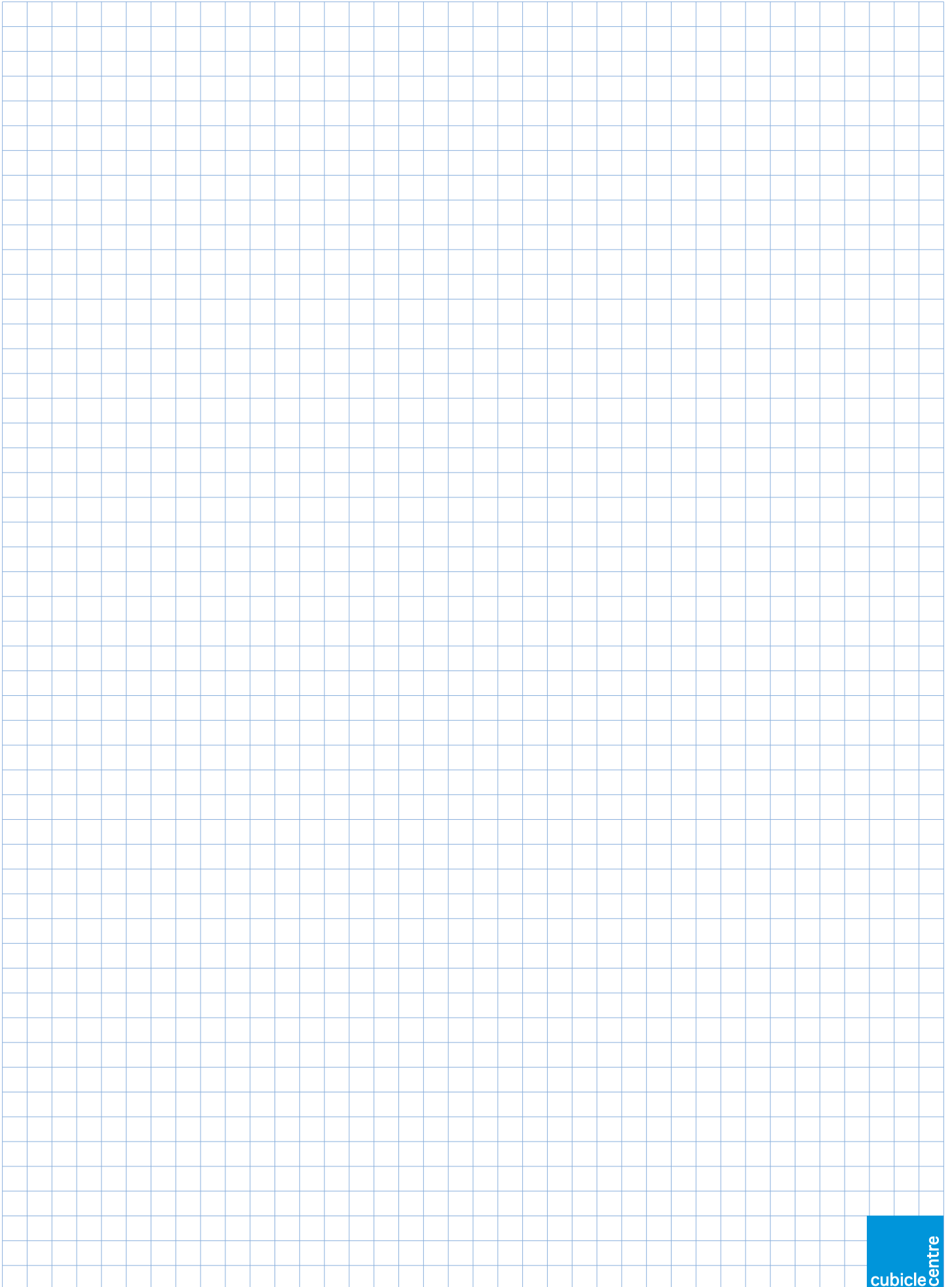

Notes

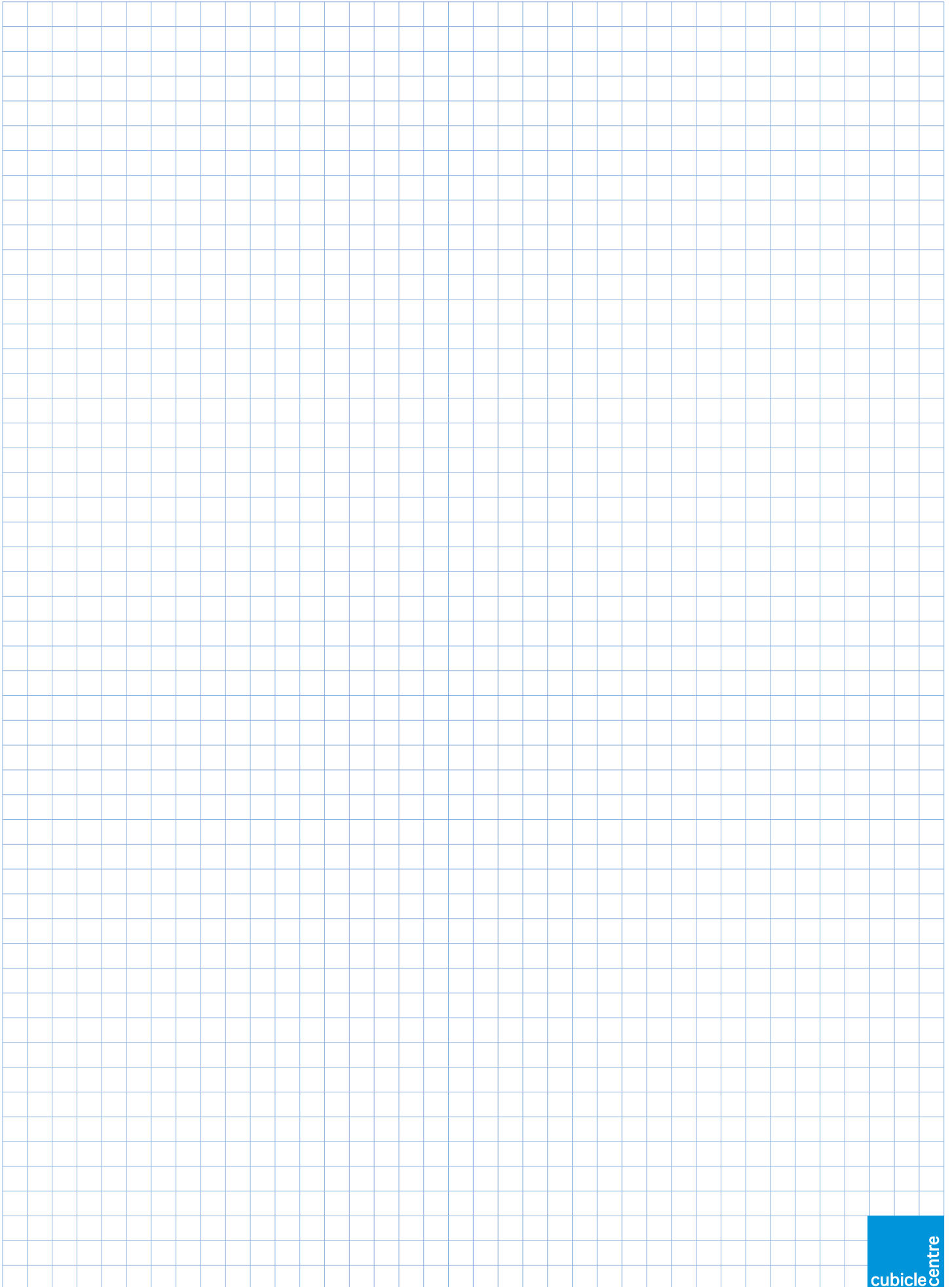

Commercial washroom products online

Whether it be a full washroom fitout or a replacement tap, we have the online solution, affordable and fast.

- Cubicle Panels & Vanity Units
- Commercial Toilet Packs
- Washbasins
- Urinals
- Washroom Packs
- Doc M Packs
- Brassware/Taps
- Showerwall
- Flush Plates
- Commercial Showers
- Stainless Steel
- Washroom Accessories

DELABIE

NYMAS

SIAMP

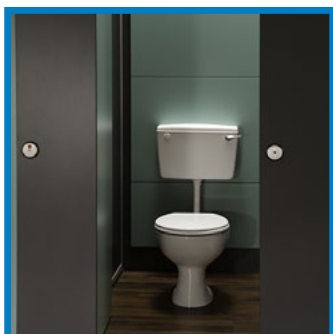

plumbware.co.uk

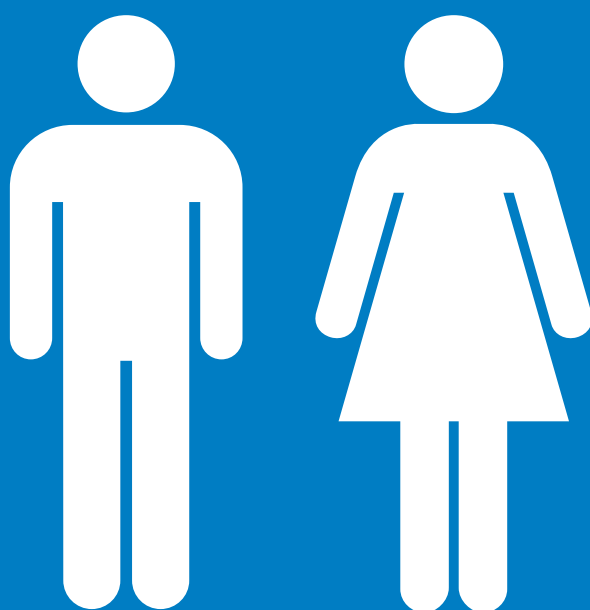

cubicle centre

Tel: 01924 457600 | Email: sales@washroomcubicles.co.uk | Web: www.washroomcubicles.co.uk

Cubicle Centre, Caldervale Business Park, Huddersfield Road, Ravensthorpe, West Yorkshire, WF13 3JL

Cubicle Centre is the trading name of DART Cubicles LLP. Registered in England No. OC376041. Printed January 2022.